



Ultra-Wideband, > 40dB Gain Adjust Range, Linear in dB VARIABLE GAIN AMPLIFIER

FEATURES

- 710MHz SMALL-SIGNAL BANDWIDTH (G = +2V/V)
- 320MHz, 4V_{pp} BANDWIDTH (G = +10V/V)
- 0.1dB GAIN FLATNESS to 135MHz
- 2500V/μs SLEW RATE
- > 40dB GAIN ADJUST RANGE
- HIGH GAIN ACCURACY: 20dB ±0.3dB
- HIGH OUTPUT CURRENT: ±90mA

APPLICATIONS

- AGC RECEIVERS with RSSI
- DIFFERENTIAL LINE RECEIVERS
- PULSE AMPLITUDE COMPENSATION
- VARIABLE ATTENUATORS
- VOLTAGE-TUNABLE ACTIVE FILTERS

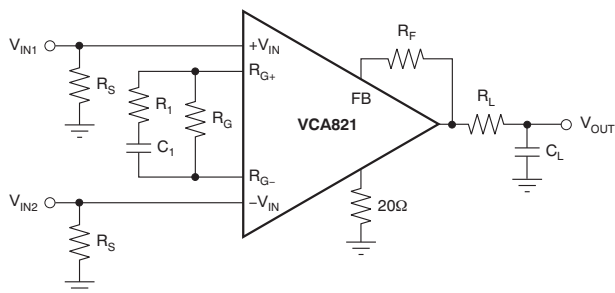

Differential Equalizer

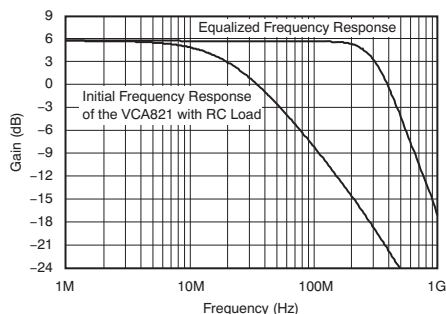

Differential Equalization of an RC Load

DESCRIPTION

The VCA821 is a dc-coupled, wideband, linear in dB, continuously variable, voltage-controlled gain amplifier. It provides a differential input to single-ended conversion with a high-impedance gain control input used to vary the gain down 40dB from the nominal maximum gain set by the gain resistor (R_G) and feedback resistor (R_F).

The VCA821 internal architecture consists of two input buffers and an output current feedback amplifier stage integrated with a multiplier core to provide a complete variable gain amplifier (VGA) system that does not require external buffering. The maximum gain is set externally with two resistors, providing flexibility in designs. The maximum gain is intended to be set between 6dB and 32dB. Operating from ±5V supplies, the gain control voltage for the VCA821 adjusts the gain linearly in dB as the control voltage varies from 0V to +2V. For example, set at a maximum gain of 20dB, the VCA821 provides 20dB, at $V_G = +2V$, to less than -20dB at $V_G = 0V$. The VCA821 offers excellent gain linearity. For a 20dB maximum gain, and a gain-control input voltage varying between +1V and +2V, the gain does not deviate by more than ±0.3dB (maximum at +25°C).

VCA821 RELATED PRODUCTS

SINGLES	DUALS	GAIN ADJUST RANGE (dB)	INPUT NOISE (nV/√Hz)	SIGNAL BANDWIDTH (MHz)
VCA810	—	80	2.4	35
—	VCA2612	45	1.25	80
—	VCA2613	45	1	80
—	VCA2615	52	0.8	50
—	VCA2617	48	4.1	50
VCA820	—	40	8.2	150
VCA821	—	40	6.0	420
VCA822	—	40	8.2	150
VCA824	—	40	6.0	420



Please be aware that an important notice concerning availability, standard warranty, and use in critical applications of Texas Instruments semiconductor products and disclaimers thereto appears at the end of this data sheet.

X2Y is a trademark of X2Y Attenuators LLC.

All other trademarks are the property of their respective owners.



This integrated circuit can be damaged by ESD. Texas Instruments recommends that all integrated circuits be handled with appropriate precautions. Failure to observe proper handling and installation procedures can cause damage.

ESD damage can range from subtle performance degradation to complete device failure. Precision integrated circuits may be more susceptible to damage because very small parametric changes could cause the device not to meet its published specifications.

ORDERING INFORMATION⁽¹⁾

PRODUCT	PACKAGE-LEAD	PACKAGE DESIGNATOR	SPECIFIED TEMPERATURE RANGE	PACKAGE MARKING	ORDERING NUMBER	TRANSPORT MEDIA, QUANTITY
VCA821	SO-14	D	–40°C to +85°C	VCA821ID	VCA821ID	Rail, 50
					VCA821IDR	Tape and Reel, 2500
VCA821	MSOP-10	DGS	–40°C to +85°C	BOR	VCA821IDGST	Tape and Reel, 250
					VCA821IDGSR	Tape and Reel, 2500

(1) For the most current package and ordering information see the Package Option Addendum at the end of this document, or see the TI web site at www.ti.com.

ABSOLUTE MAXIMUM RATINGS

over operating free-air temperature range (unless otherwise noted)

	VCA821	UNIT
Power Supply	±6.5	V
Internal Power Dissipation	See Thermal Characteristics	
Input Voltage Range	±V _S	V
Storage Temperature Range	–65 to +125	°C
Lead Temperature (soldering, 10s)	+260	°C
Junction Temperature (T _J)	+150	°C
Junction Temperature (T _J), Maximum Continuous Operation	+140	C
ESD Rating:	Human Body Model (HBM)	2000
	Charge Device Model (CDM)	1000
	Machine Model	200

PIN CONFIGURATIONS

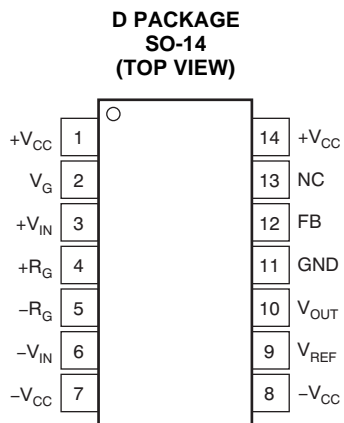

NC = No Connection

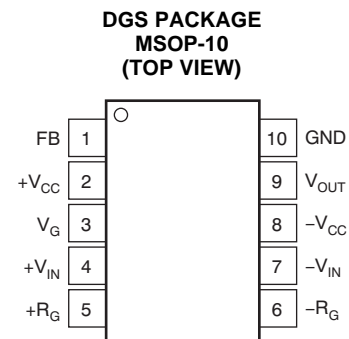

ELECTRICAL CHARACTERISTICS: $V_S = \pm 5V$

 At $A_{V_{MAX}} = 20dB$, $R_F = 402\Omega$, $R_G = 80\Omega$, $R_L = 100\Omega$, unless otherwise noted.

PARAMETER	CONDITIONS	VCA821				UNITS	MIN/ MAX	TEST LEVEL ⁽¹⁾
		TYP	MIN/MAX OVER TEMPERATURE					
		+25°C	+25°C ⁽²⁾	0°C to 70°C ⁽³⁾	-40°C to +85°C ⁽³⁾			
AC PERFORMANCE								
Small-Signal Bandwidth	$G = 6dB, V_O = 500mV_{PP}$	710				MHz	typ	C
	$G = 20dB, V_O = 500mV_{PP}$	420				MHz	typ	C
	$G = 40dB, V_O = 500mV_{PP}$	170				MHz	typ	C
Large-Signal Bandwidth	$G = 20dB, V_O = 4V_{PP}$	320				MHz	typ	C
Gain Control Bandwidth	$V_O = 200mV_{PP}$	330	240	235	235	MHz	min	B
Bandwidth for 0.1dB Flatness	$G = 20dB, V_O = 200mV_{PP}$	135				MHz	typ	C
Slew Rate	$G = 20dB, V_O = 5V$ Step	2500	1800	1700	1700	V/ μs	min	B
Rise-and-Fall Time	$G = 20dB, V_O = 5V$ Step	1.5	1.8	1.9	1.9	ns	max	B
Settling Time to 0.01%	$G = 20dB, V_O = 5V$ Step	11				ns	typ	C
Harmonic Distortion								
2nd Harmonic	$V_O = 2V_{PP}, f = 20MHz$	-66	-64	-64	-64	dBc	min	B
3rd Harmonic	$V_O = 2V_{PP}, f = 20MHz$	-63	-61	-61	-61	dBc	min	B
Input Voltage Noise	$f > 100kHz$	6.0				nV/ \sqrt{Hz}	typ	C
Input Current Noise	$f > 100kHz$	2.6				pA/ \sqrt{Hz}	typ	C
GAIN CONTROL								
Absolute Gain Error	$G_{MAX} = 20dB, V_G = 2V$	± 0.1	± 0.4	± 0.5	± 0.6	dB	max	A
V_{crit0}		0.85				V	typ	C
V_{Slope}		0.09				V	typ	C
Absolute Gain Error	$G_{MAX} = 20dB, V_G = 1V, (G = 18.06$ dB)	± 0.3	± 0.4	± 0.5	± 0.6	dB	max	A
Gain at $V_G = 0.2V$	relative to max gain	-26	-24	-24	-23	dB	max	A
Gain Control Bias Current		10	16	16.6	16.7	μA	max	A
Average Gain Control Bias Current Drift				± 12	± 12	nA/ $^{\circ}C$	max	B
Gain Control Input Impedance		1.5 0.6				M Ω pF	typ	C
DC PERFORMANCE								
Input Offset Voltage	$G = 20dB, V_{CM} = 0V, V_G = 1V$	± 4	± 17	± 17.8	± 19	mV	max	A
Average Input Offset Voltage Drift	$G = 20dB, V_{CM} = 0V, V_G = 1V$			30	30	$\mu V/^{\circ}C$	max	B
Input Bias Current	$G = 20dB, V_{CM} = 0V, V_G = 1V$	19	25	29	31	μA	max	A
Average Input Bias Current Drift	$G = 20dB, V_{CM} = 0V, V_G = 1V$			90	90	nA/ $^{\circ}C$	max	B
Input Offset Current	$G = 20dB, V_{CM} = 0V, V_G = 1V$	± 0.5	± 2.5	± 3.2	± 3.5	μA	max	A
Average Input Offset Current Drift	$G = 20dB, V_{CM} = 0V, V_G = 1V$			± 16	± 16	nA/ $^{\circ}C$	max	B
Max Current Through Gain Resistance		± 2.6	± 2.55	± 2.55	± 2.5	mA	max	B
INPUT								
Most Positive Common Mode Input Voltage	$R_L = 100\Omega$	+1.6	+1.6	+1.6	+1.6	V	min	A
Most Negative Common Mode Input Voltage	$R_L = 100\Omega$	-2.1	-2.1	-2.1	-2.1	V	max	A
Common-Mode Rejection Ratio	$V_{CM} = \pm 0.5V$	80	65	60	60	dB	min	A
Input Impedance								
Differential		0.9 0.6				M Ω pF	typ	C
Common-Mode		1 2				M Ω pF	typ	C

- (1) Test levels: (A) 100% tested at +25°C. Over temperature limits set by characterization and simulation. (B) Limits set by characterization and simulation. (C) Typical value only for information.
- (2) Junction temperature = ambient for +25°C tested specifications.
- (3) Junction temperature = ambient at low temperature limit; junction temperature = ambient +23°C at high temperature limit for over temperature specifications.

ELECTRICAL CHARACTERISTICS: $V_S = \pm 5V$ (continued)At $A_{V_{MAX}} = 20dB$, $R_F = 402\Omega$, $R_G = 80\Omega$, $R_L = 100\Omega$, unless otherwise noted.

PARAMETER	CONDITIONS	VCA821				UNITS	MIN/ MAX	TEST LEVEL ⁽¹⁾
		TYP	MIN/MAX OVER TEMPERATURE					
		+25°C	+25°C ⁽²⁾	0°C to 70°C ⁽³⁾	–40°C to +85°C ⁽³⁾			
OUTPUT								
Output Voltage Swing	$R_L = 1k\Omega$	±3.9	±3.6	±3.4	±3.3	V	min	A
	$R_L = 100\Omega$	±3.6	±3.5	±3.3	±3.2	V	min	A
Output Current	$V_O = 0V$, $R_L = 10\Omega$	±90	±60	±50	±45	mA	min	A
Output Impedance	$G = +10V/V$, $f > 100kHz$	0.01				Ω	typ	C
POWER SUPPLY								
Specified Operating Voltage		±5				V	typ	C
Minimum Operating Voltage		±3.5				V	typ	C
Maximum Operating Voltage			±6	±6	±6	V	max	A
Maximum Quiescent Current	$V_G = 1V$	34	35	35.5	36	mA	max	A
Minimum Quiescent Current	$V_G = 1V$	34	32.5	32	31.5	mA	max	A
Power-Supply Rejection Ratio (–PSRR)		–68	–61	–59	–58	dB	min	A
THERMAL CHARACTERISTICS								
Specified Operating Range D Package		–40 to +85				°C	typ	C
Thermal Resistance θ_{JA}	Junction-to-Ambient							
DGS MSOP-10		130				°C/W	typ	C
D SO-14		80				°C/W	typ	C

TYPICAL CHARACTERISTICS: $V_S = \pm 5V$, DC Parameters

At $T_A = +25^\circ C$, $R_L = 100\Omega$, $V_G = +2V$, and V_{IN} = single-ended input on $+V_{IN}$ with $-V_{IN}$ at ground, unless otherwise noted.

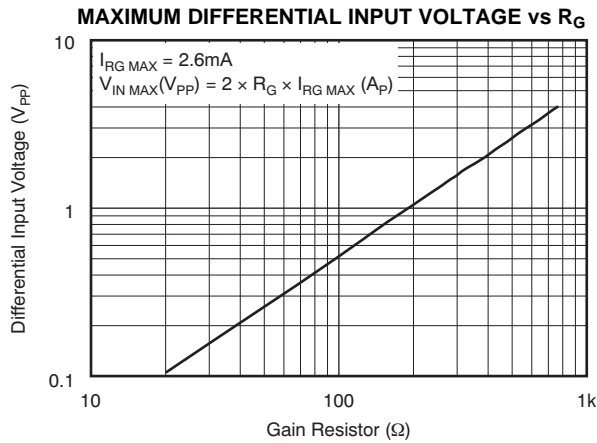

Figure 1.

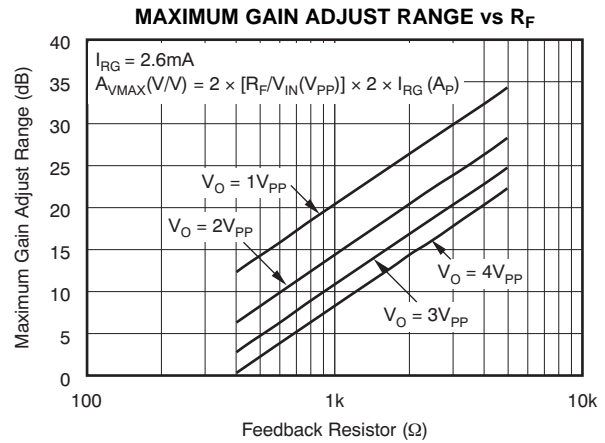

Figure 2.

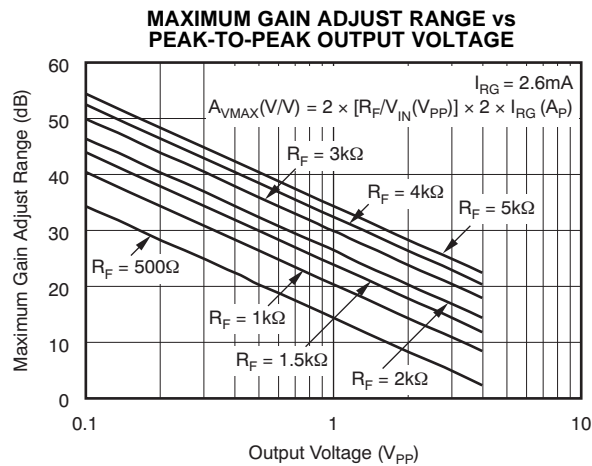

Figure 3.

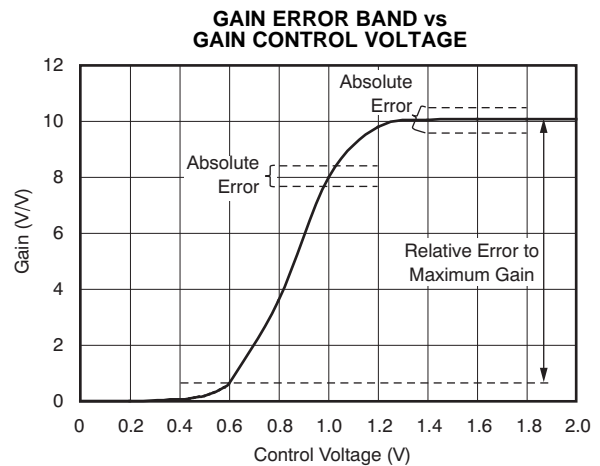

Figure 4.

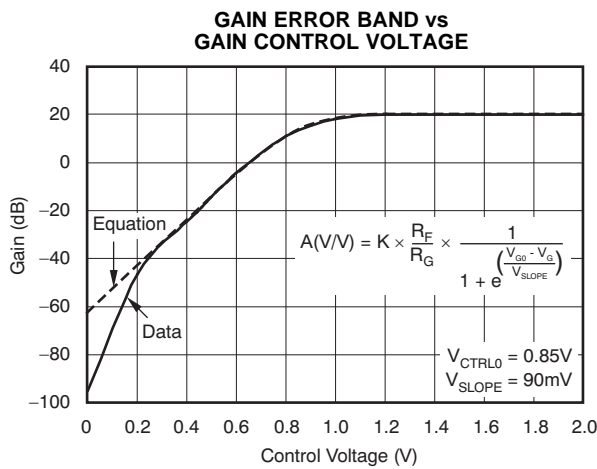

Figure 5.

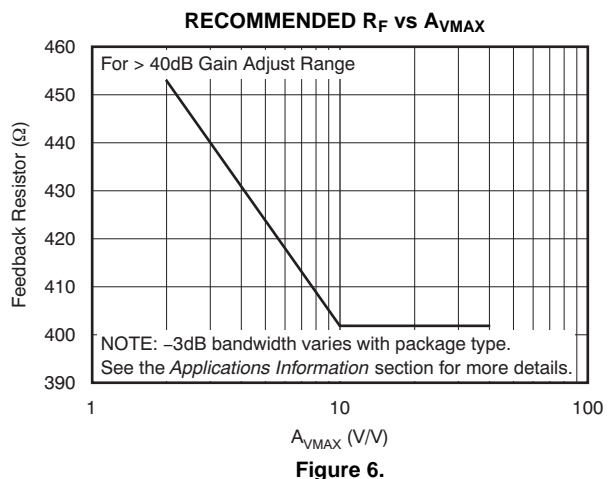

Figure 6.

TYPICAL CHARACTERISTICS: $V_S = \pm 5V$, DC and Power-Supply Parameters

At $T_A = +25^\circ C$, $R_L = 100\Omega$, $V_G = +2V$, and V_{IN} = single-ended input on $+V_{IN}$ with $-V_{IN}$ at ground, unless otherwise noted.

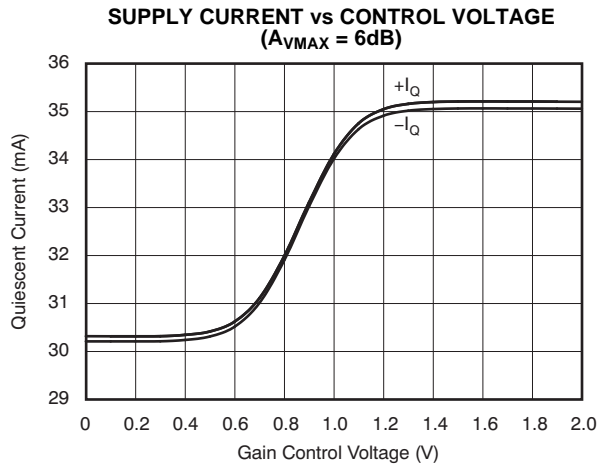

Figure 7.

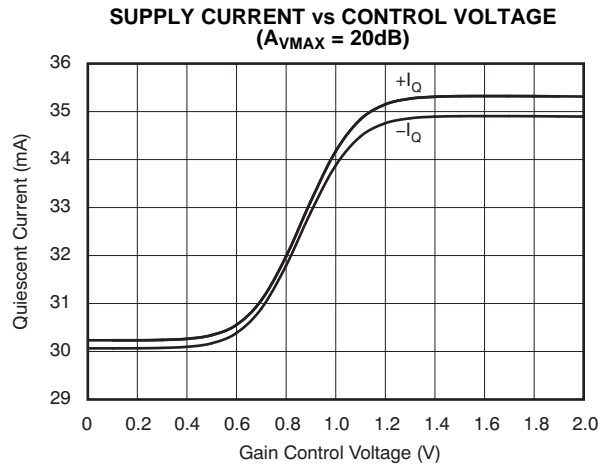

Figure 8.

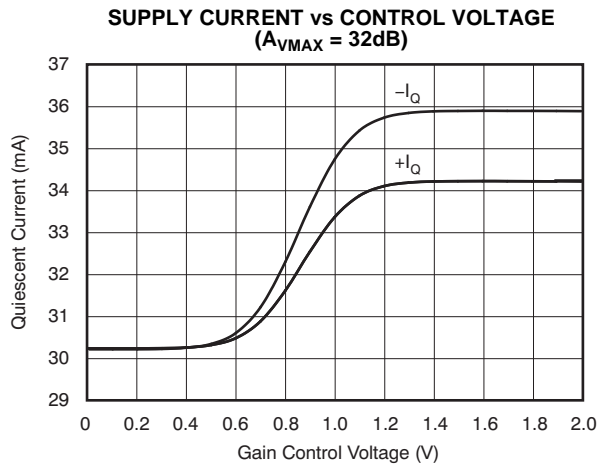

Figure 9.

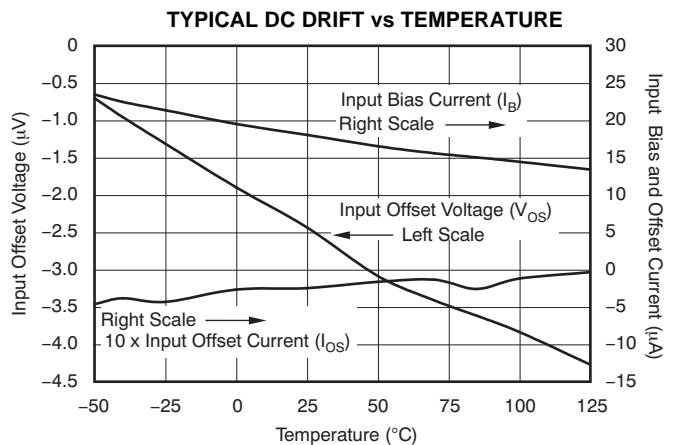

Figure 10.

TYPICAL CHARACTERISTICS: $V_S = \pm 5V$, $A_{VMAX} = 6dB$

At $T_A = +25^\circ C$, $R_L = 100\Omega$, $R_F = 453\Omega$, $R_G = 453\Omega$, $V_G = +2V$, V_{IN} = single-ended input on $+V_{IN}$ with $-V_{IN}$ at ground, and SO-14 package, unless otherwise noted.

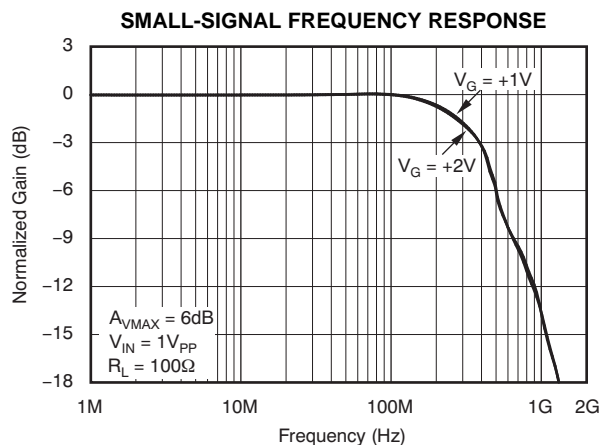

Figure 11.

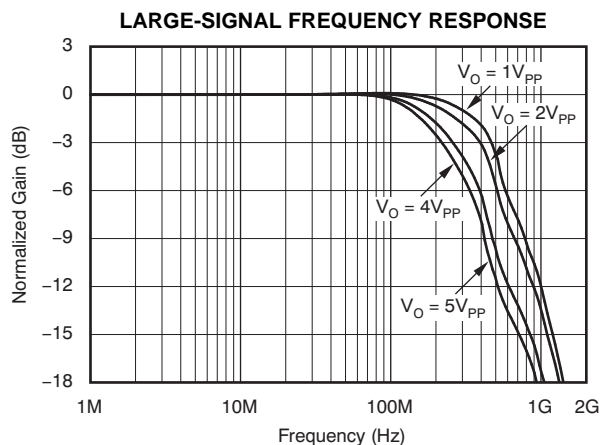

Figure 12.

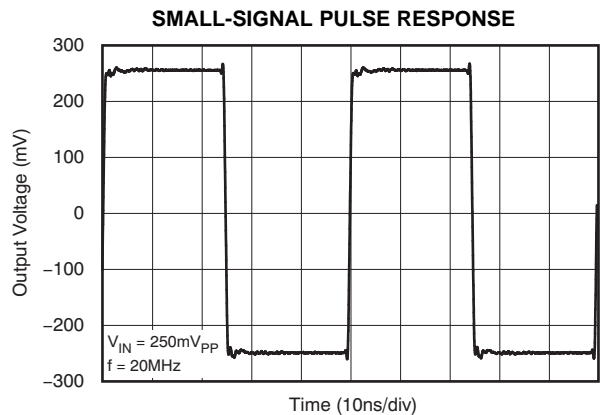

Figure 13.

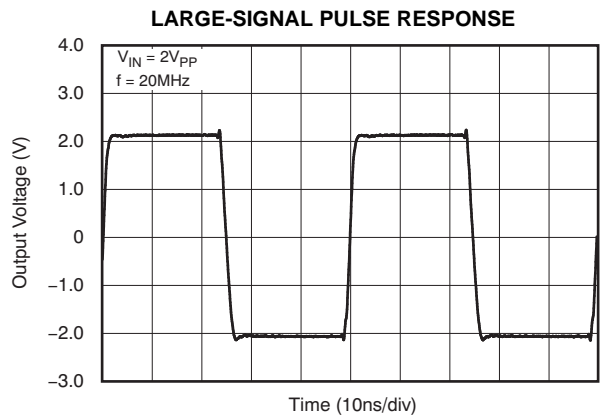

Figure 14.

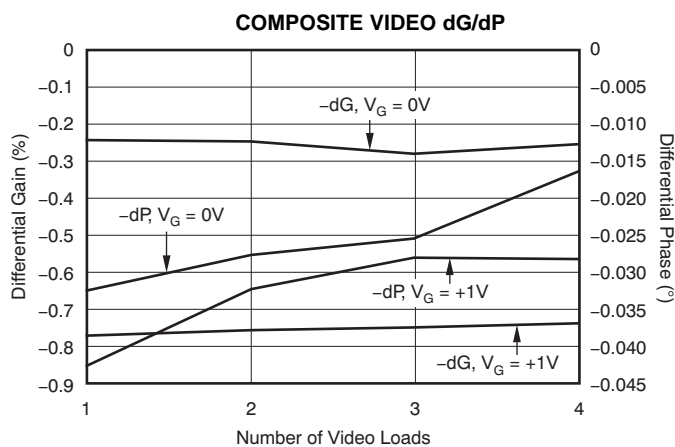

Figure 15.

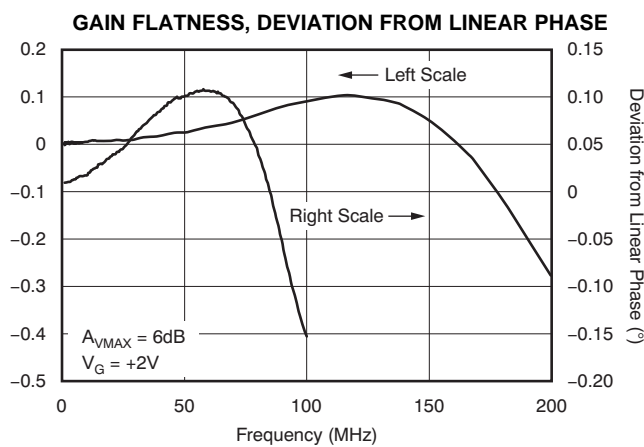

Figure 16.

TYPICAL CHARACTERISTICS: $V_S = \pm 5V$, $A_{VMAX} = 6dB$ (continued)

At $T_A = +25^\circ C$, $R_L = 100\Omega$, $R_F = 453\Omega$, $R_G = 453\Omega$, $V_G = +2V$, V_{IN} = single-ended input on $+V_{IN}$ with $-V_{IN}$ at ground, and SO-14 package, unless otherwise noted.

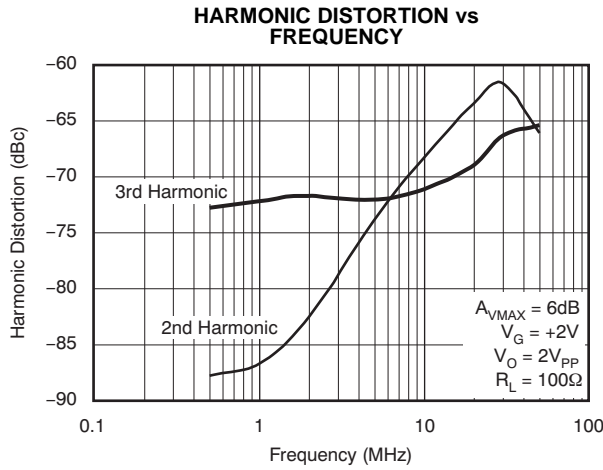

Figure 17.

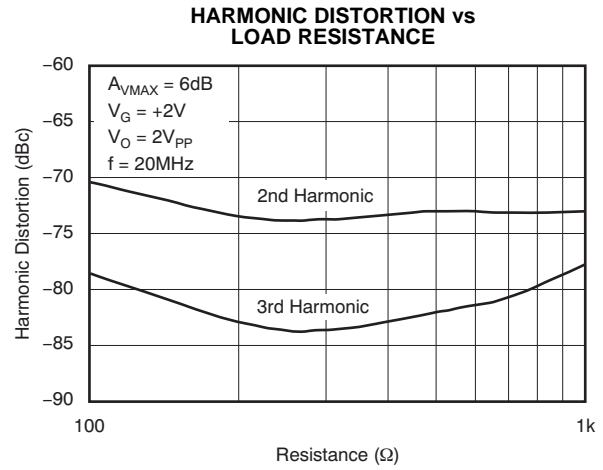

Figure 18.

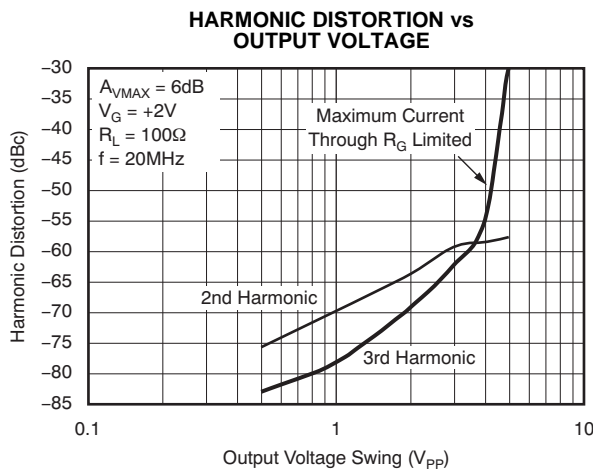

Figure 19.

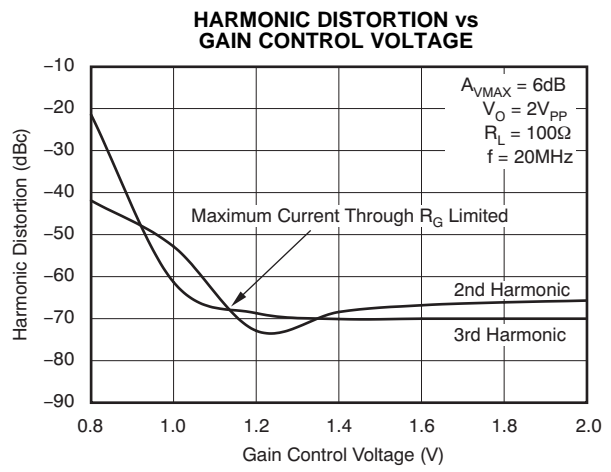

Figure 20.

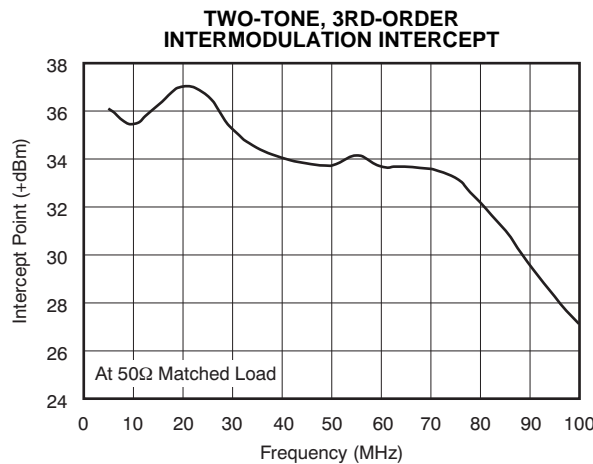

Figure 21.

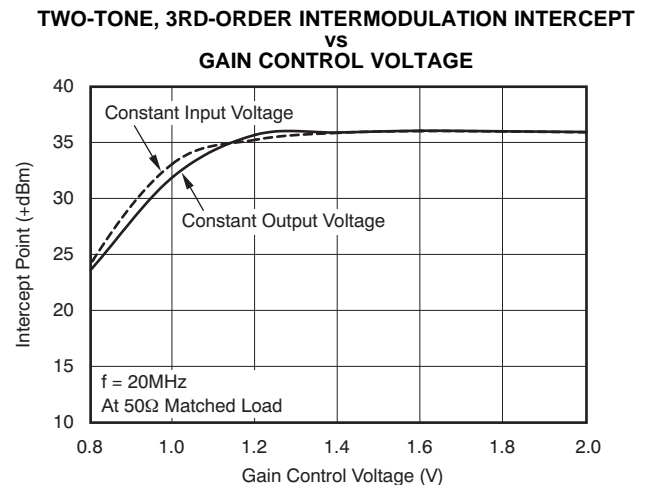

Figure 22.

TYPICAL CHARACTERISTICS: $V_S = \pm 5V$, $A_{VMAX} = 6dB$ (continued)

At $T_A = +25^\circ C$, $R_L = 100\Omega$, $R_F = 453\Omega$, $R_G = 453\Omega$, $V_G = +2V$, $V_{IN} =$ single-ended input on $+V_{IN}$ with $-V_{IN}$ at ground, and SO-14 package, unless otherwise noted.

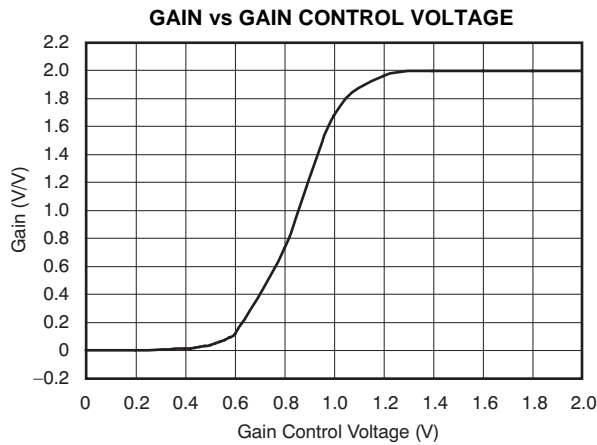

Figure 23.

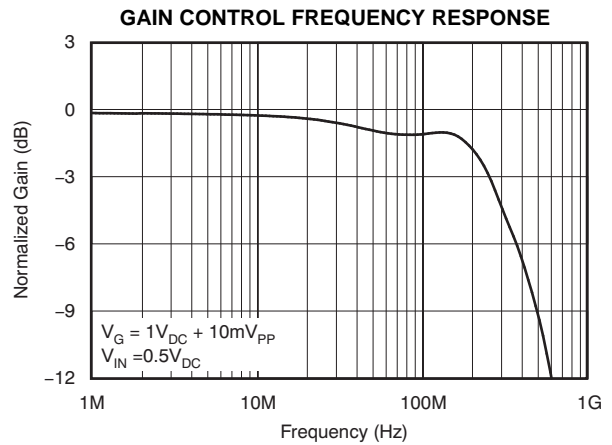

Figure 24.

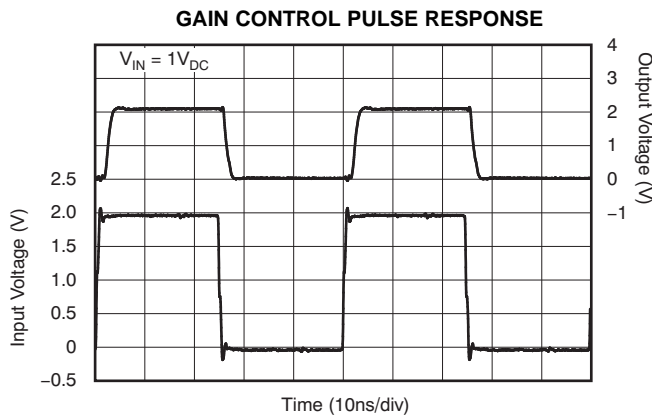

Figure 25.

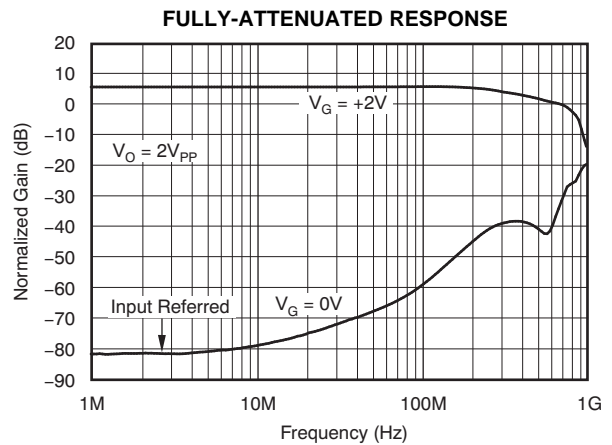

Figure 26.

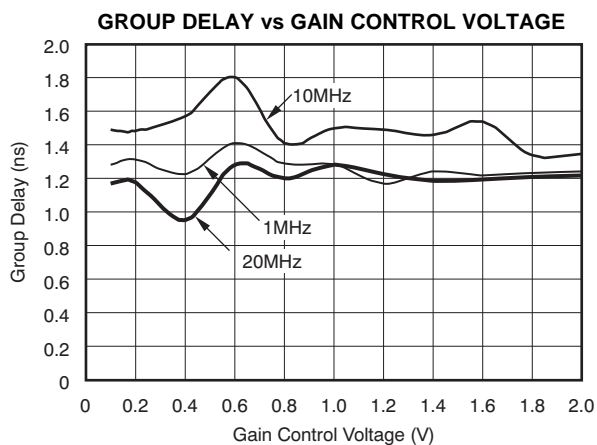

Figure 27.

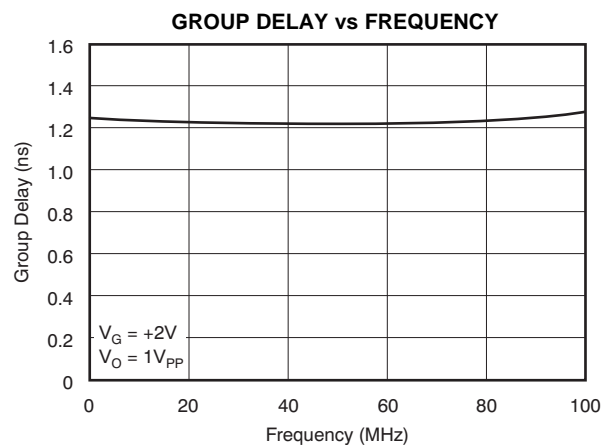

Figure 28.

TYPICAL CHARACTERISTICS: $V_S = \pm 5V$, $A_{VMAX} = 6dB$ (continued)

At $T_A = +25^\circ C$, $R_L = 100\Omega$, $R_F = 453\Omega$, $R_G = 453\Omega$, $V_G = +2V$, V_{IN} = single-ended input on $+V_{IN}$ with $-V_{IN}$ at ground, and SO-14 package, unless otherwise noted.

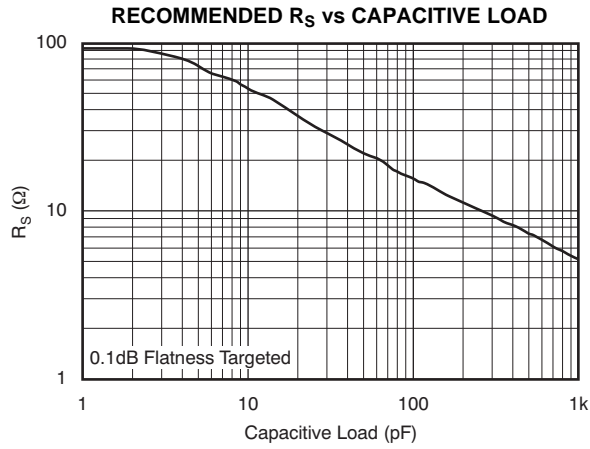

Figure 29.

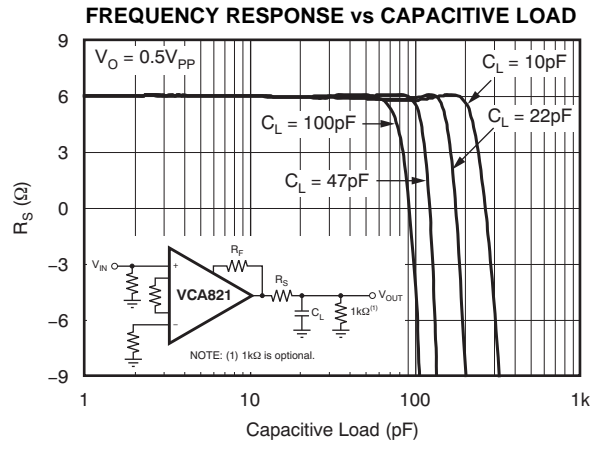

Figure 30.

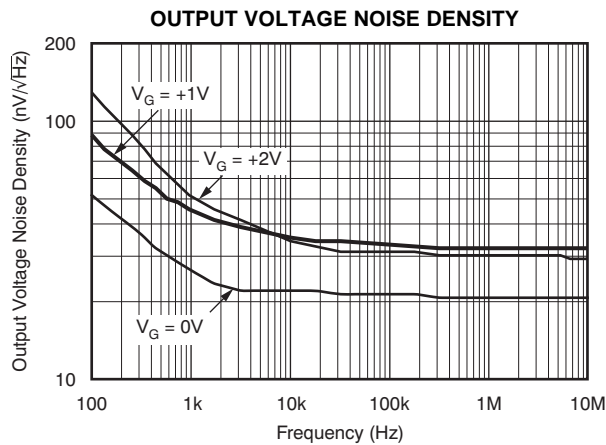

Figure 31.

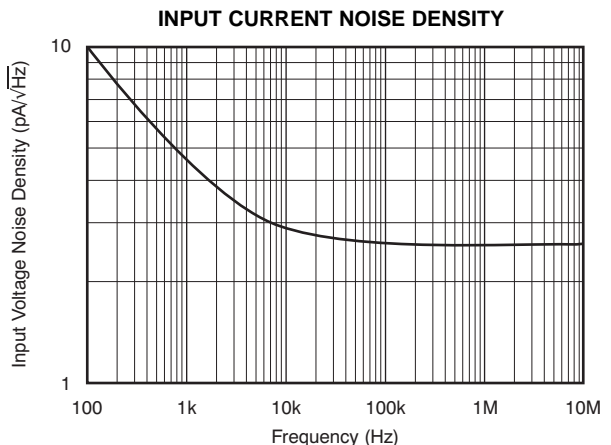

Figure 32.

TYPICAL CHARACTERISTICS: $V_S = \pm 5V$, $A_{VMAX} = 20dB$

At $T_A = +25^\circ C$, $R_L = 100\Omega$, $R_F = 402\Omega$, $R_G = 80\Omega$, $V_G = +2V$, and V_{IN} = single-ended input on $+V_{IN}$ with $-V_{IN}$ at ground, unless otherwise noted.

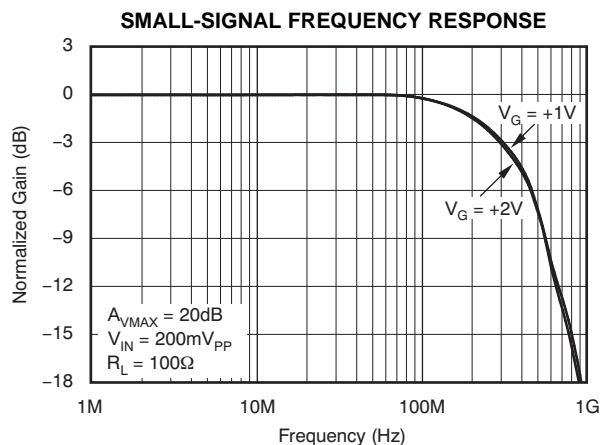

Figure 33.

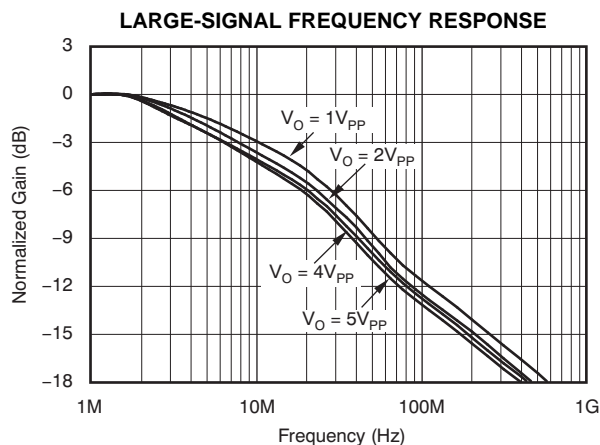

Figure 34.

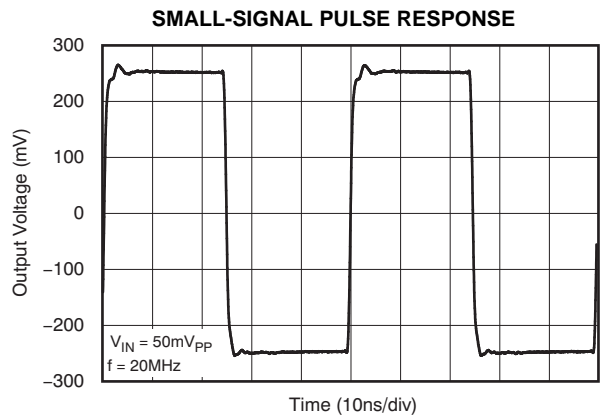

Figure 35.

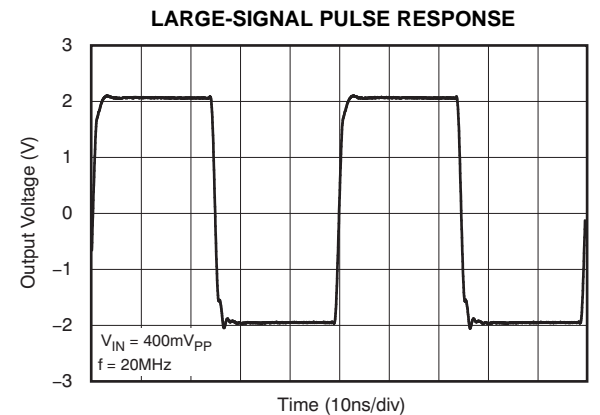

Figure 36.

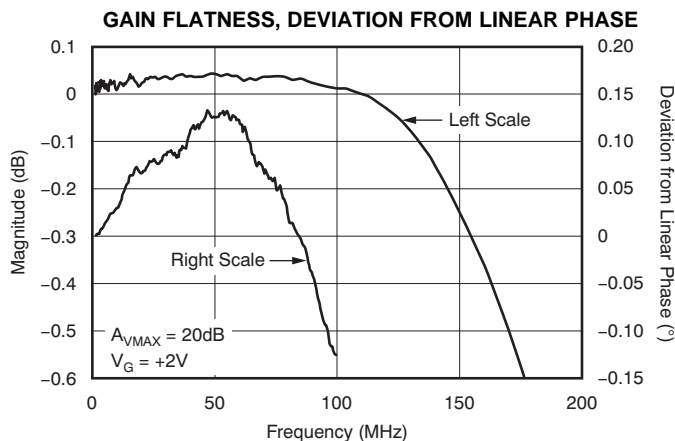

Figure 37.

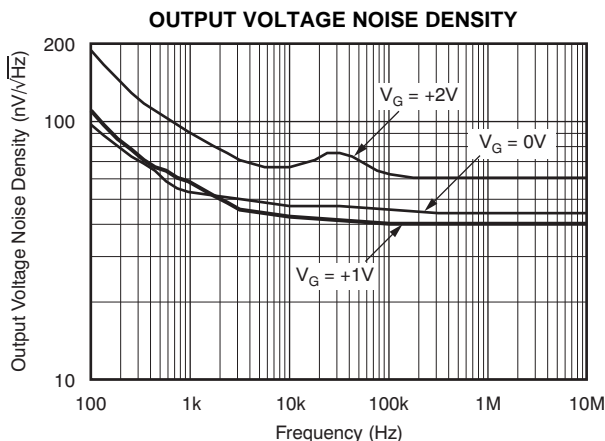

Figure 38.

TYPICAL CHARACTERISTICS: $V_S = \pm 5V$, $A_{VMAX} = 20dB$ (continued)

At $T_A = +25^\circ C$, $R_L = 100\Omega$, $R_F = 402\Omega$, $R_G = 80\Omega$, $V_G = +2V$, and V_{IN} = single-ended input on $+V_{IN}$ with $-V_{IN}$ at ground, unless otherwise noted.

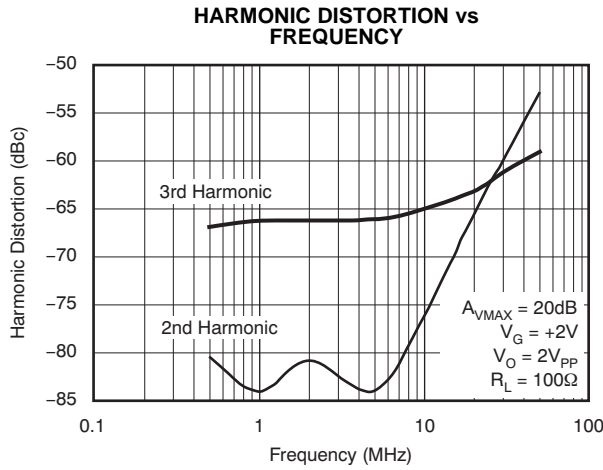

Figure 39.

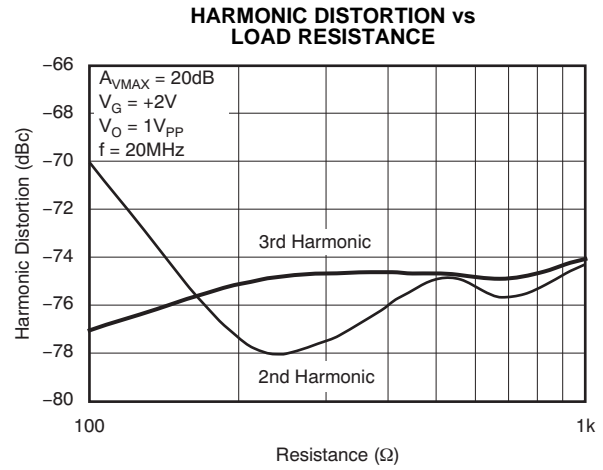

Figure 40.

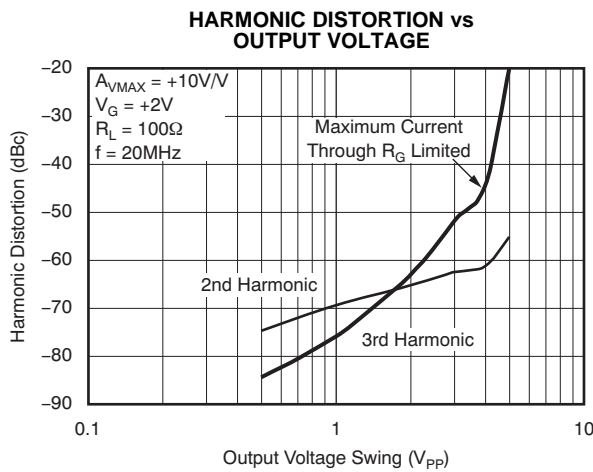

Figure 41.

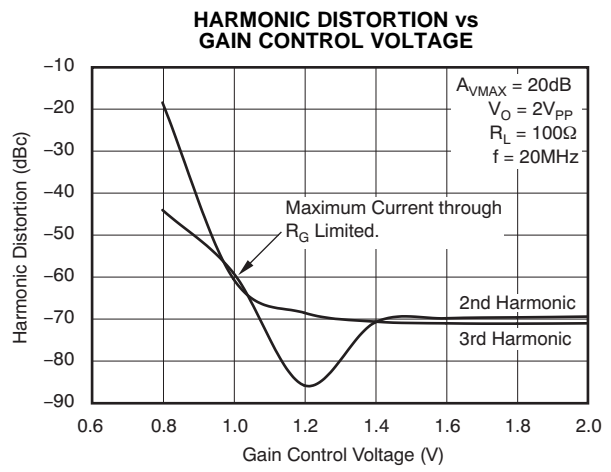

Figure 42.

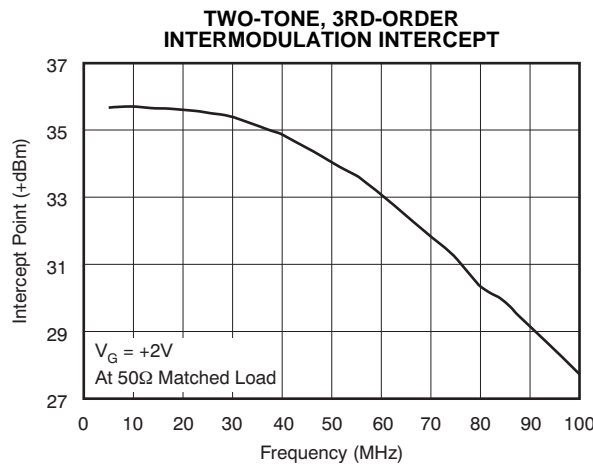

Figure 43.

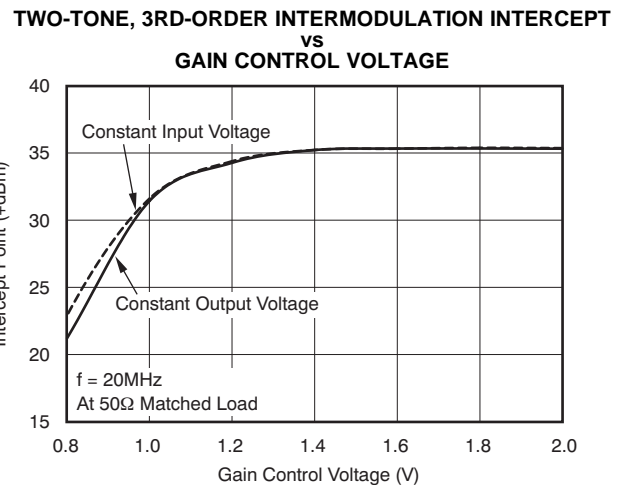

Figure 44.

TYPICAL CHARACTERISTICS: $V_S = \pm 5V$, $A_{VMAX} = 20dB$ (continued)

At $T_A = +25^\circ C$, $R_L = 100\Omega$, $R_F = 402\Omega$, $R_G = 80\Omega$, $V_G = +2V$, and V_{IN} = single-ended input on $+V_{IN}$ with $-V_{IN}$ at ground, unless otherwise noted.

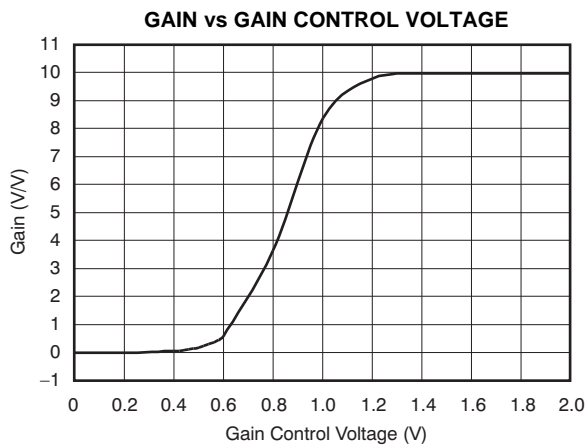

Figure 45.

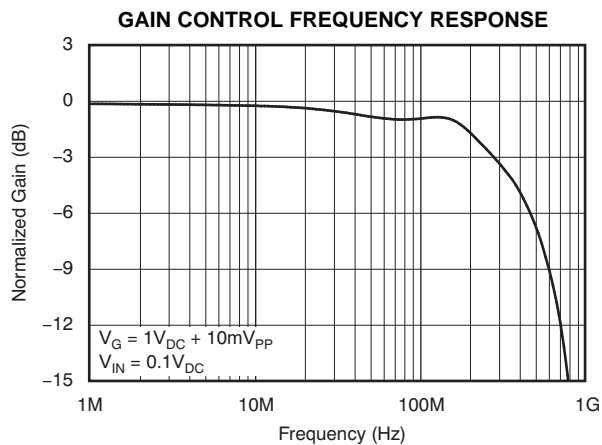

Figure 46.

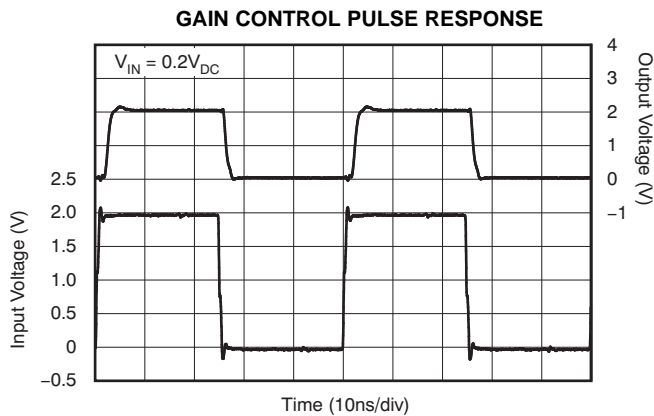

Figure 47.

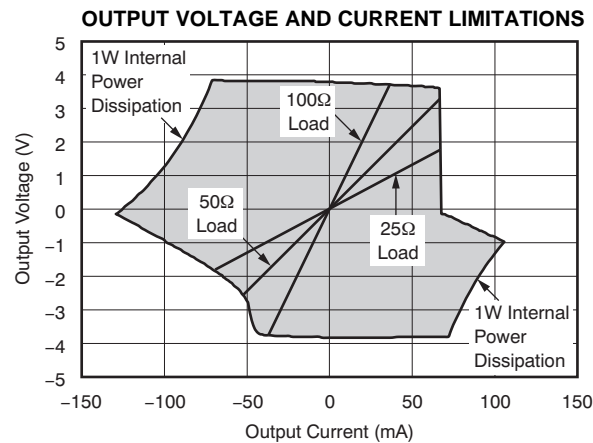

Figure 48.

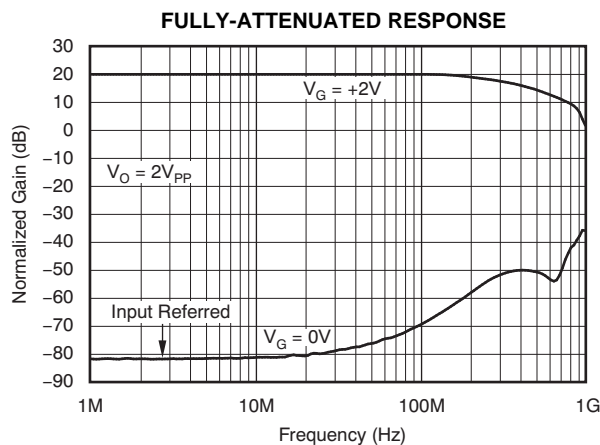

Figure 49.

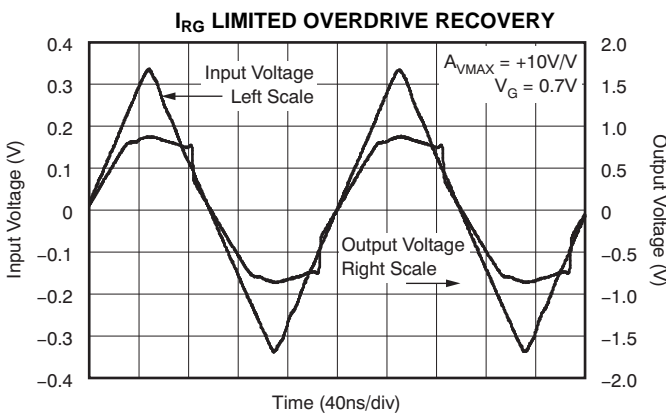

Figure 50.

TYPICAL CHARACTERISTICS: $V_S = \pm 5V$, $A_{VMAX} = 20dB$ (continued)

At $T_A = +25^\circ C$, $R_L = 100\Omega$, $R_F = 402\Omega$, $R_G = 80\Omega$, $V_G = +2V$, and V_{IN} = single-ended input on $+V_{IN}$ with $-V_{IN}$ at ground, unless otherwise noted.

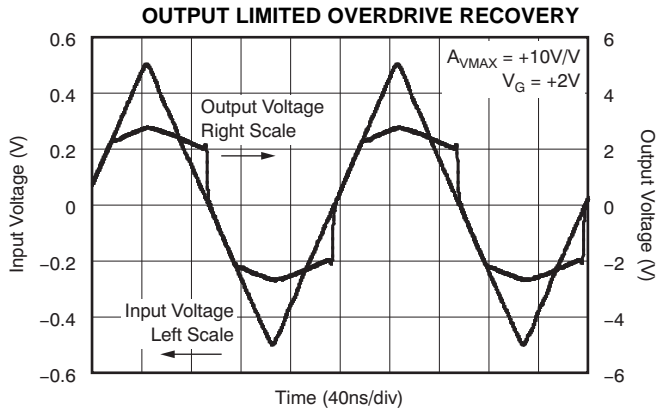

Figure 51.

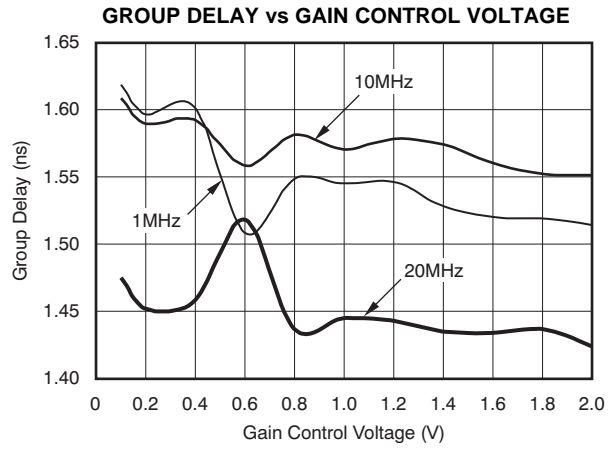

Figure 52.

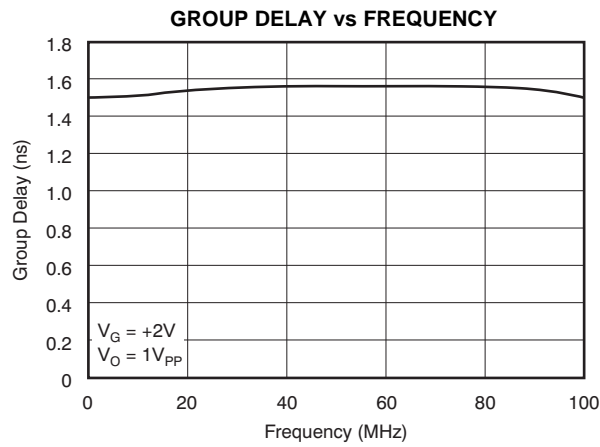

Figure 53.

TYPICAL CHARACTERISTICS: $V_S = \pm 5V$, $A_{VMAX} = 32dB$

At $T_A = +25^\circ C$, $R_L = 100\Omega$, $R_F = 402\Omega$, $R_G = 18\Omega$, $V_G = +2V$, V_{IN} = single-ended input on $+V_{IN}$ with $-V_{IN}$ at ground, and SO-14 package, unless otherwise noted.

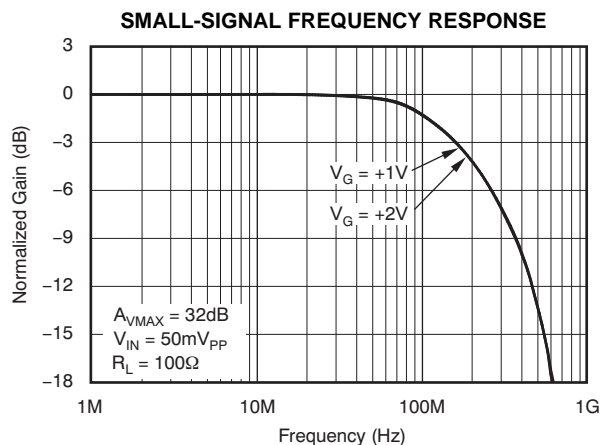

Figure 54.

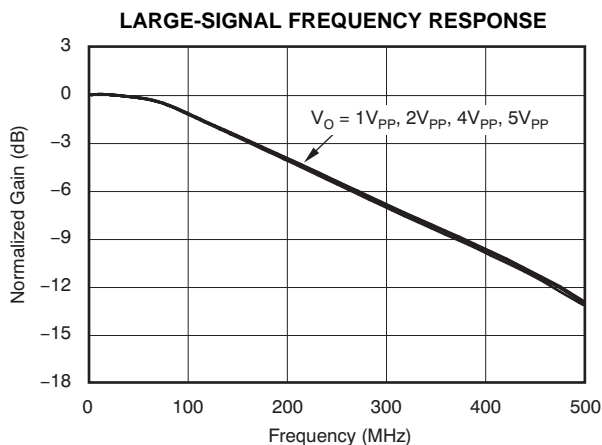

Figure 55.

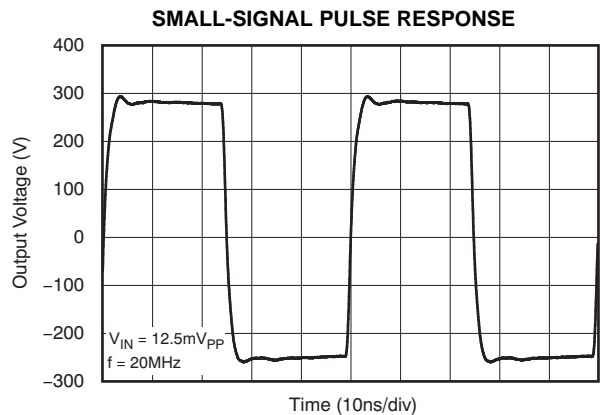

Figure 56.

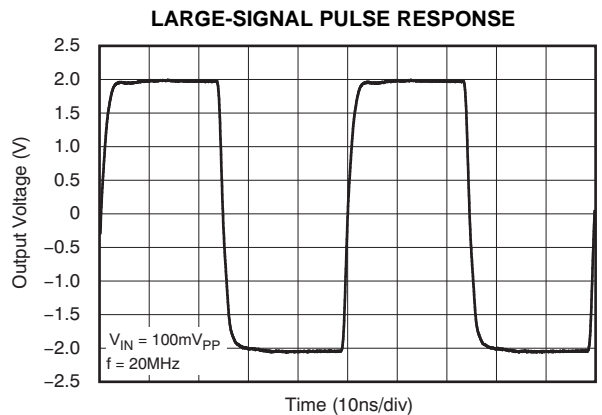

Figure 57.

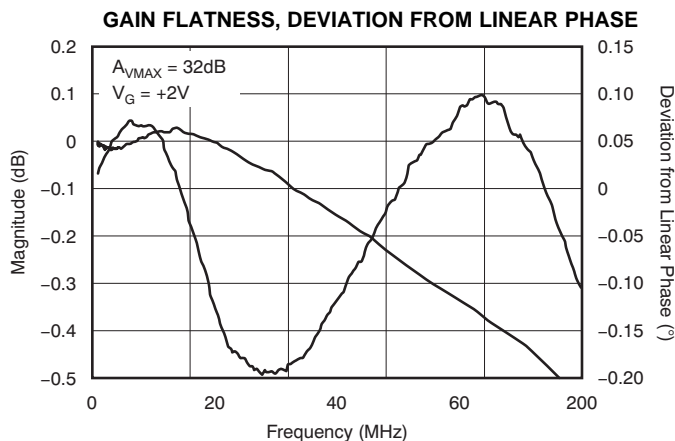

Figure 58.

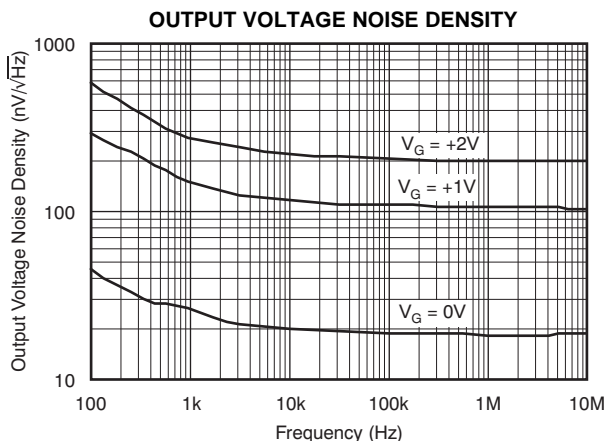

Figure 59.

TYPICAL CHARACTERISTICS: $V_S = \pm 5V$, $A_{VMAX} = 32dB$ (continued)

At $T_A = +25^\circ C$, $R_L = 100\Omega$, $R_F = 402\Omega$, $R_G = 18\Omega$, $V_G = +2V$, $V_{IN} =$ single-ended input on $+V_{IN}$ with $-V_{IN}$ at ground, and SO-14 package, unless otherwise noted.

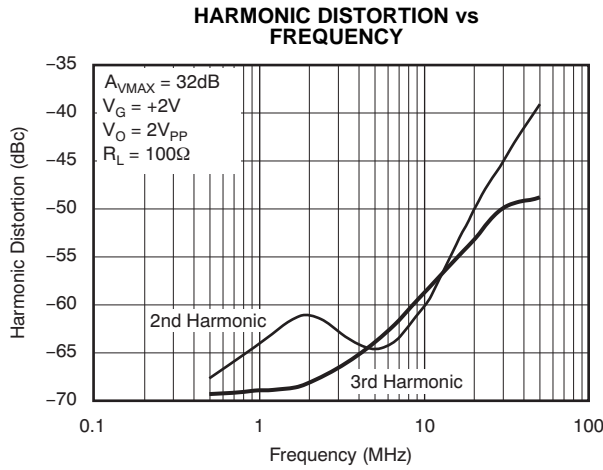

Figure 60.

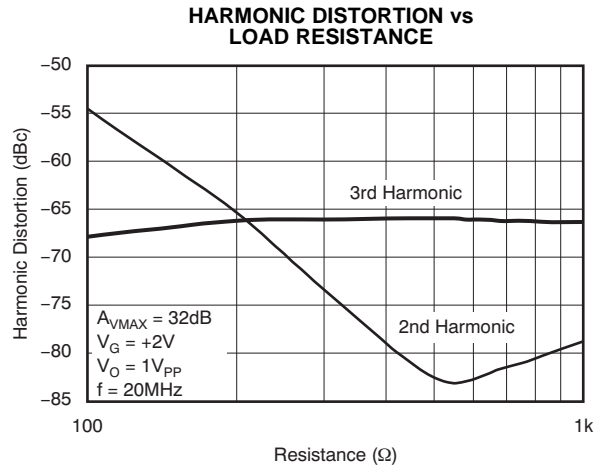

Figure 61.

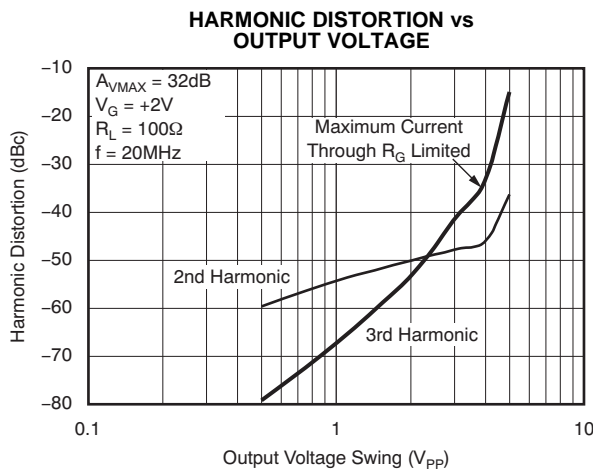

Figure 62.

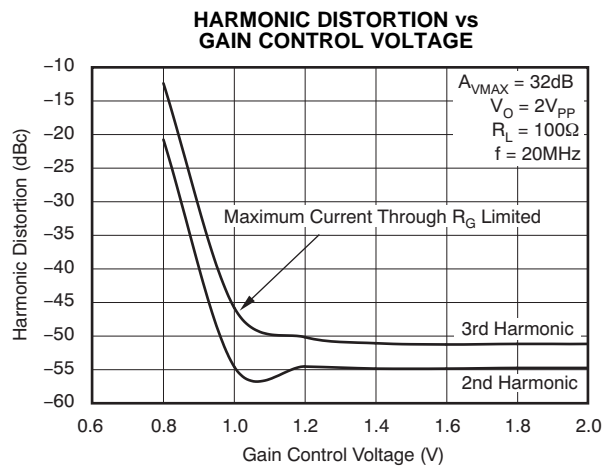

Figure 63.

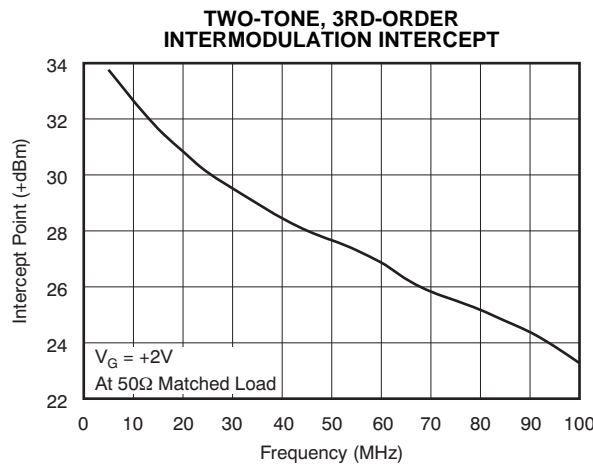

Figure 64.

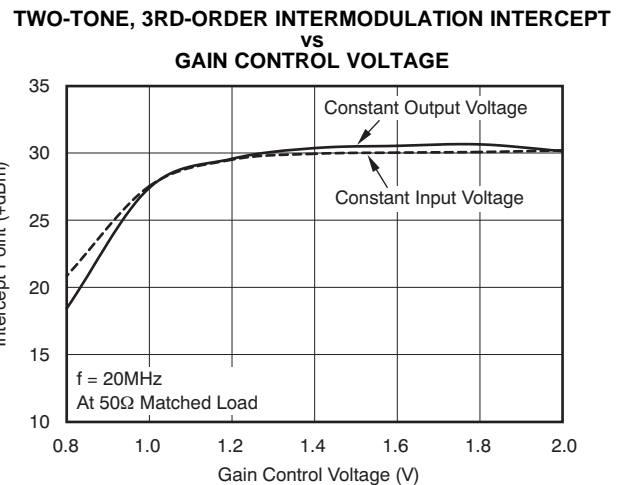

Figure 65.

TYPICAL CHARACTERISTICS: $V_S = \pm 5V$, $A_{VMAX} = 32dB$ (continued)

At $T_A = +25^\circ C$, $R_L = 100\Omega$, $R_F = 402\Omega$, $R_G = 18\Omega$, $V_G = +2V$, $V_{IN} =$ single-ended input on $+V_{IN}$ with $-V_{IN}$ at ground, and SO-14 package, unless otherwise noted.

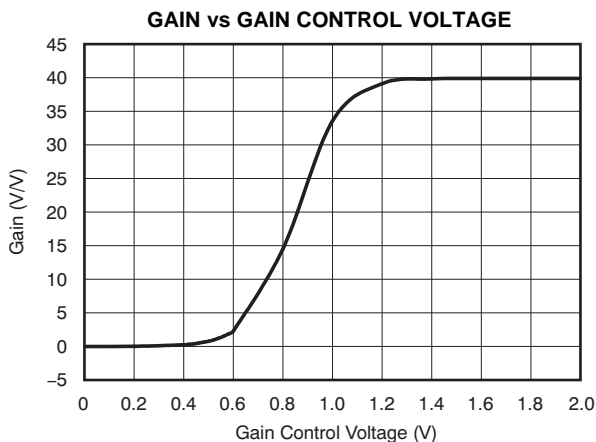

Figure 66.

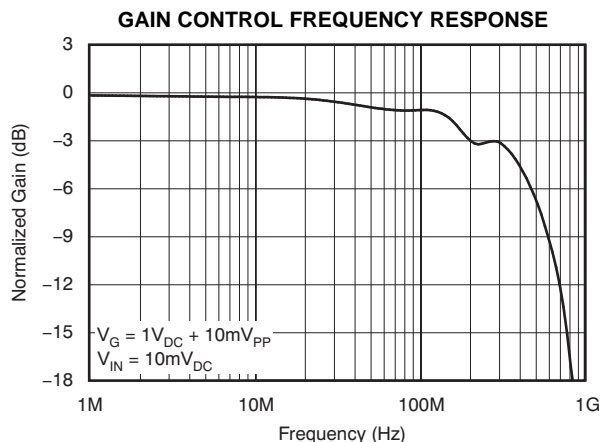

Figure 67.

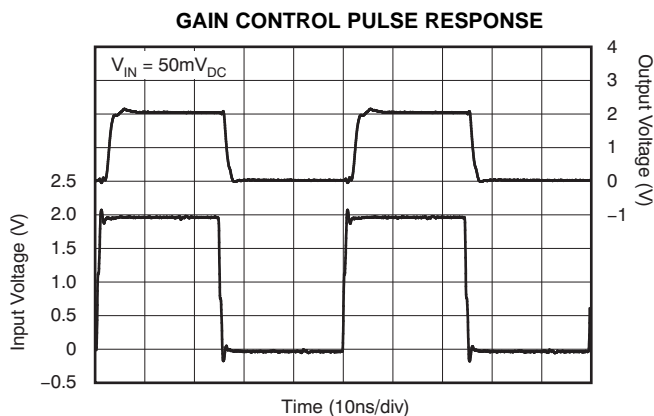

Figure 68.

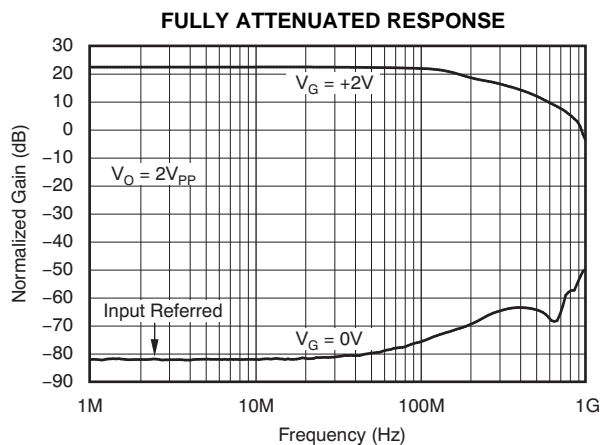

Figure 69.

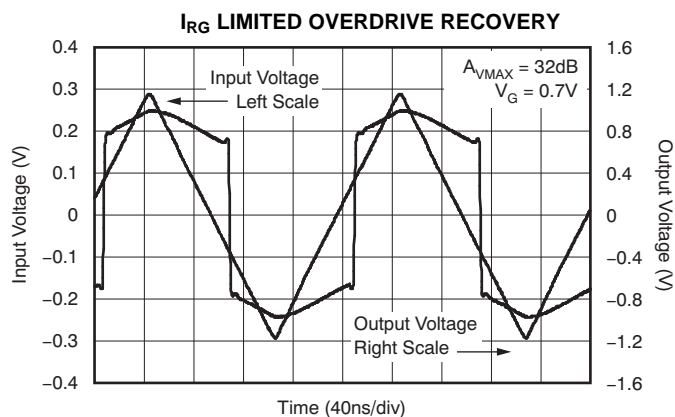

Figure 70.

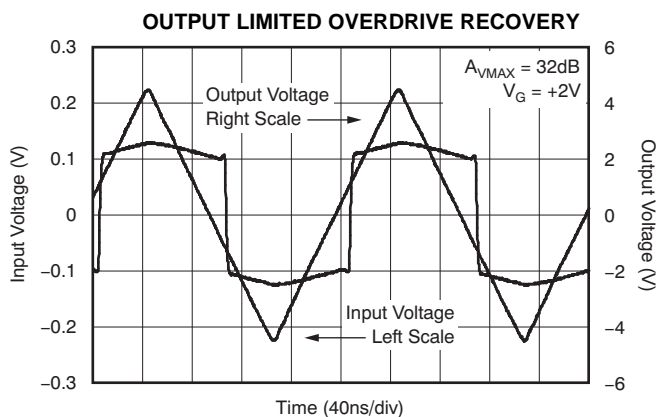

Figure 71.

TYPICAL CHARACTERISTICS: $V_S = \pm 5V$, $A_{V_{MAX}} = 32dB$ (continued)

At $T_A = +25^\circ C$, $R_L = 100\Omega$, $R_F = 402\Omega$, $R_G = 18\Omega$, $V_G = +2V$, V_{IN} = single-ended input on $+V_{IN}$ with $-V_{IN}$ at ground, and SO-14 package, unless otherwise noted.

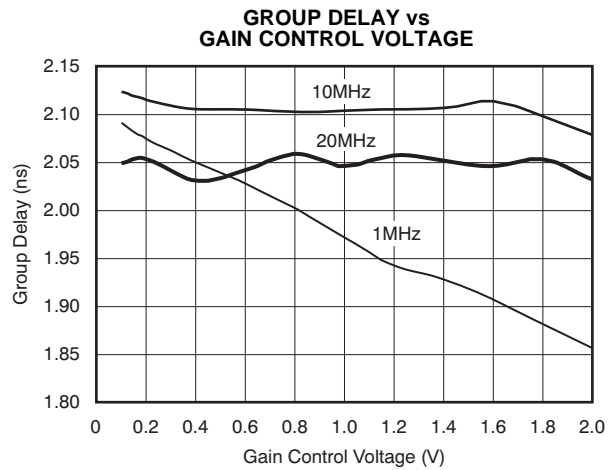

Figure 72.

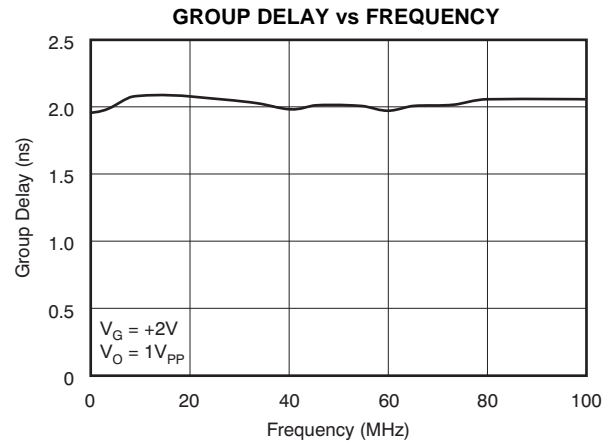

Figure 73.

APPLICATION INFORMATION

WIDEBAND VARIABLE GAIN AMPLIFIER OPERATION

The VCA821 provides an exceptional combination of high output power capability with a wideband, greater than 40dB gain adjust range, linear in dB variable gain amplifier. The VCA821 input stage places the transconductance element between two input buffers, using the output currents as the forward signal. As the differential input voltage rises, a signal current is generated through the gain element. This current is then mirrored and gained by a factor of two before reaching the multiplier. The other input of the multiplier is the voltage gain control pin, V_G . Depending on the voltage present on V_G , up to two times the gain current is provided to the transimpedance output stage. The transimpedance output stage is a current-feedback amplifier providing high output current capability and high slew rate, 2500V/ μ s. This exceptional full-power performance comes at the price of relatively high quiescent current (34mA), but low input voltage noise for this type of architecture (6nV/ $\sqrt{\text{Hz}}$).

Figure 74 shows the dc-coupled, gain of +10V/V, dual power-supply circuit used as the basis of the ± 5 V Electrical Characteristics and Typical Characteristics.

For test purposes, the input impedance is set to 50 Ω with a resistor to ground and the output impedance is set to 50 Ω with a series output resistor. Voltage swings reported in the Electrical Characteristics table are taken directly at the input and output pins, while output power (dBm) is at the matched 50 Ω load. For the circuit in Figure 74, the total effective load is 100 Ω || 1k Ω . Note that for the SO-14 package, there is a ground pin, GND (pin 11). For the SO-14 package, this pin must be connected to ground through a 20 Ω resistor in order to avoid possible oscillations of the output stage. In the MSOP-10 package, this pin is internally connected and does not require such precaution. An X2Y™ capacitor has been used for power-supply bypassing. The combination of low inductance, high resonance frequency, and integration of three capacitors in one package (two capacitors to ground and one across the supplies) enables the VCA821 to achieve the low second-harmonic distortion reported in the Electrical Characteristics table. More information on how the VCA821 operates can be found in the Operating Suggestions section.

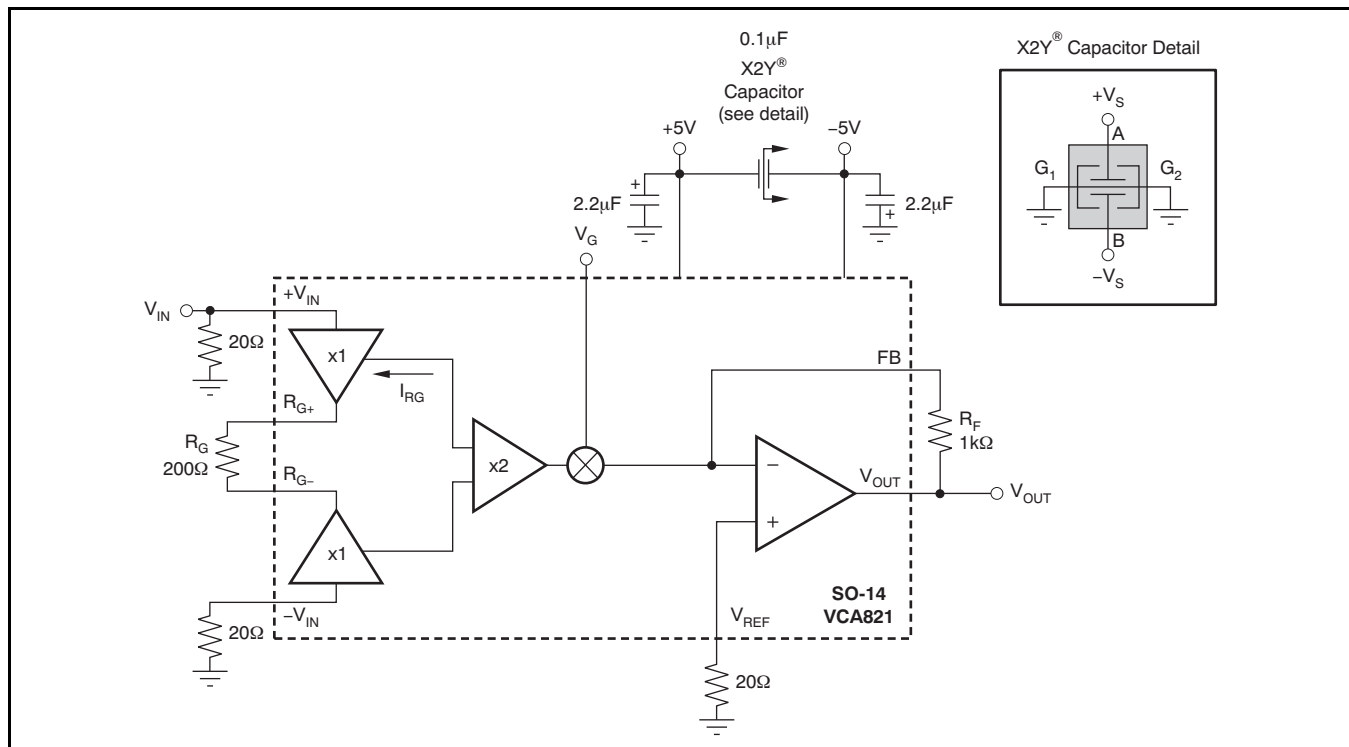

Figure 74. DC-Coupled, $A_{VMAX} = 20$ dB, Bipolar Supply Specification and Test Circuit

DIFFERENCE AMPLIFIER

Because both inputs of the VCA821 are high-impedance, a difference amplifier can be implemented without any major problem. Figure 75 shows this implementation. This circuit provides excellent common-mode rejection ratio (CMRR) as long as the input is within the CMRR range of $-2.1V$ to $+1.6V$. Note that this circuit does not make use of the gain control pin, V_G . Also, it is recommended to choose R_S such that the pole formed by R_S and the parasitic input capacitance does not limit the bandwidth of the circuit. Figure 76 shows the common-mode rejection ratio for this circuit implemented in a gain of 20dB for $V_G = +2V$. Note that because the gain control voltage is fixed and is normally set to $+2V$, the feedback element can be reduced in order to increase the bandwidth. When reducing the feedback element, make sure that the VCA821 is not limited by common-mode input voltage, the current flowing through R_G , or any other limitation described in this data sheet.

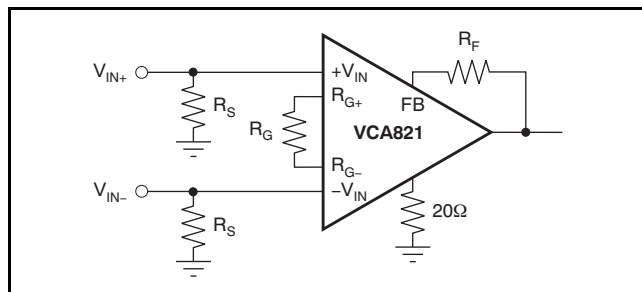

Figure 75. Difference Amplifier

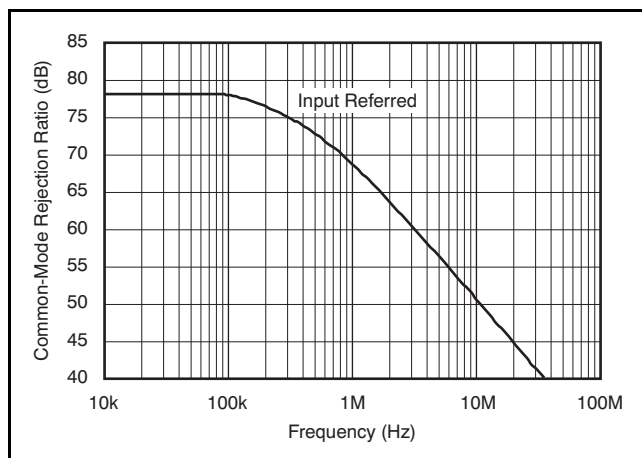

Figure 76. Common-Mode Rejection Ratio

DIFFERENTIAL EQUALIZER

If the application requires frequency shaping (the transition from one gain to another), the VCA821 can

be used advantageously because its architecture allows the application to isolate the input from the gain setting elements. Figure 77 shows an implementation of such a configuration. The transfer function is shown in Equation 1.

$$G = 2 \times \frac{R_F}{R_G} \times \frac{1 + sR_G C_1}{1 + sR_1 C_1} \tag{1}$$

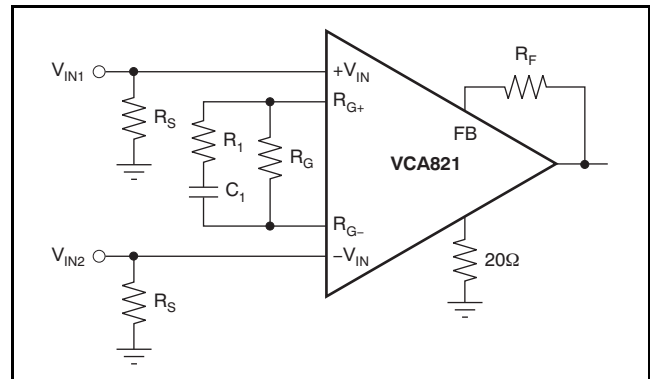

Figure 77. Differential Equalizer

This transfer function has one pole, P_1 (located at $R_G C_1$), and one zero, Z_1 (located at $R_1 C_1$). When equalizing an RC load, R_L and C_L , compensate the pole added by the load located at $R_L C_L$ with the zero Z_1 . Knowing R_L , C_L , and R_G allows the user to select C_1 as a first step and then calculate R_1 . Using $R_L = 75\Omega$, $C_L = 100pF$ and wanting the VCA821 to operate at a gain of $+2V/V$, which gives $R_F = R_G = 453\Omega$, allows the user to select $C_1 = 15.5pF$ to ensure a positive value for the resistor R_1 . With all these values known, to achieve greater than 300MHz bandwidth, R_1 can be calculated to be 20Ω. Figure 78 shows the frequency response for both the initial, unequalized frequency response and the resulting equalized frequency response.

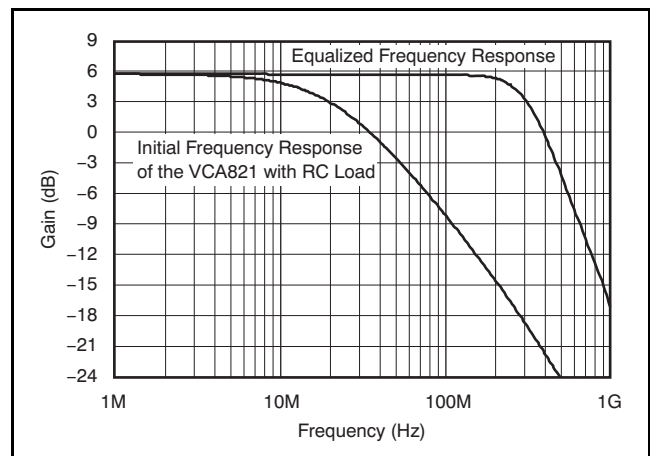

Figure 78. Differential Equalization of an RC Load

DIFFERENTIAL CABLE EQUALIZER

A differential cable equalizer can easily be implemented using the VCA821. An example of a cable equalization for 100 feet of Belden cable 1694F is illustrated in Figure 78, with Figure 79 showing the result for this implementation. This implementation has a maximum error of 0.2dB from dc to 70MHz.

Note that this implementation shows the cable attenuation side-by-side with the equalization in the same plot. For a given frequency, the equalization function realized with the VCA821 matches the cable attenuation. The circuit in Figure 80 is a driver circuit. To implement a receiver circuit, the signal is received differentially between the $+V_{IN}$ and $-V_{IN}$ inputs.

AGC LOOP

In the typical AGC loop shown in Figure 81, the OPA695 follows the VCA821 to provide 40dB of overall gain. The output of the OPA695 is rectified and integrated by an OPA820 to control the gain of the VCA821. when the output level exceeds the reference voltage (V_{REF}), the integrator ramps down reducing the gain of the AGC loop. Conversely, if the output is too small, the integrator ramps up increasing the net gain and the output voltage.

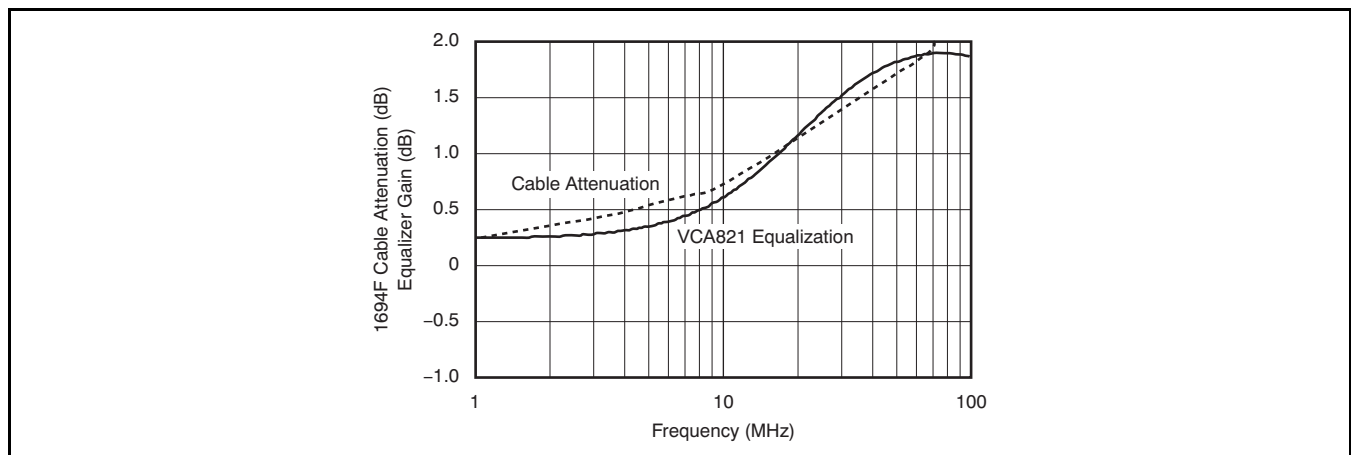

Figure 79. Cable Attenuation versus Equalizer Gain

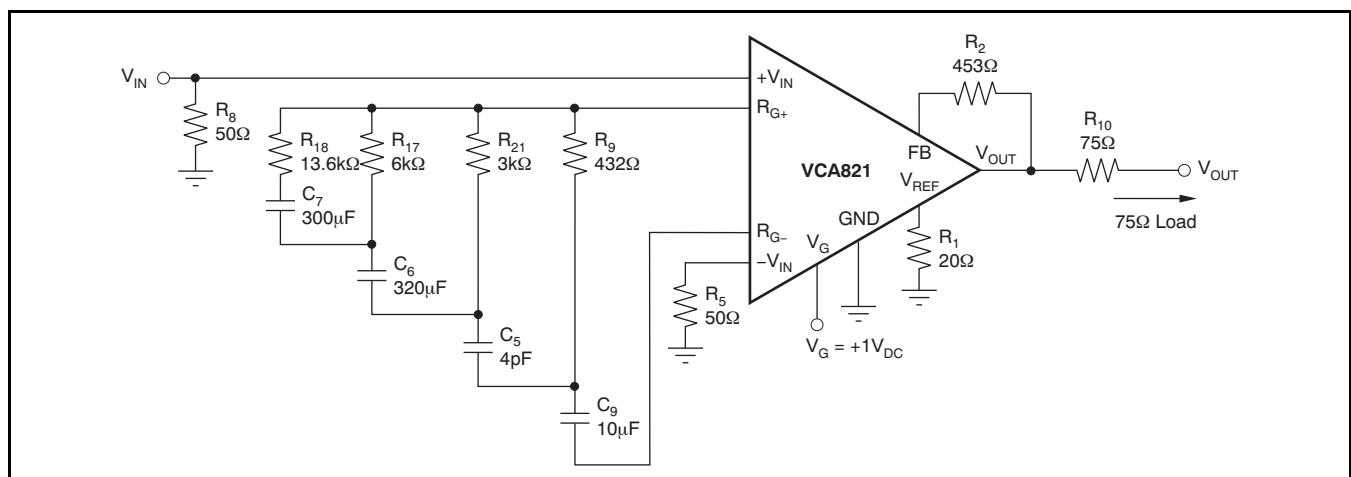

Figure 80. Differential Cable Equalizer

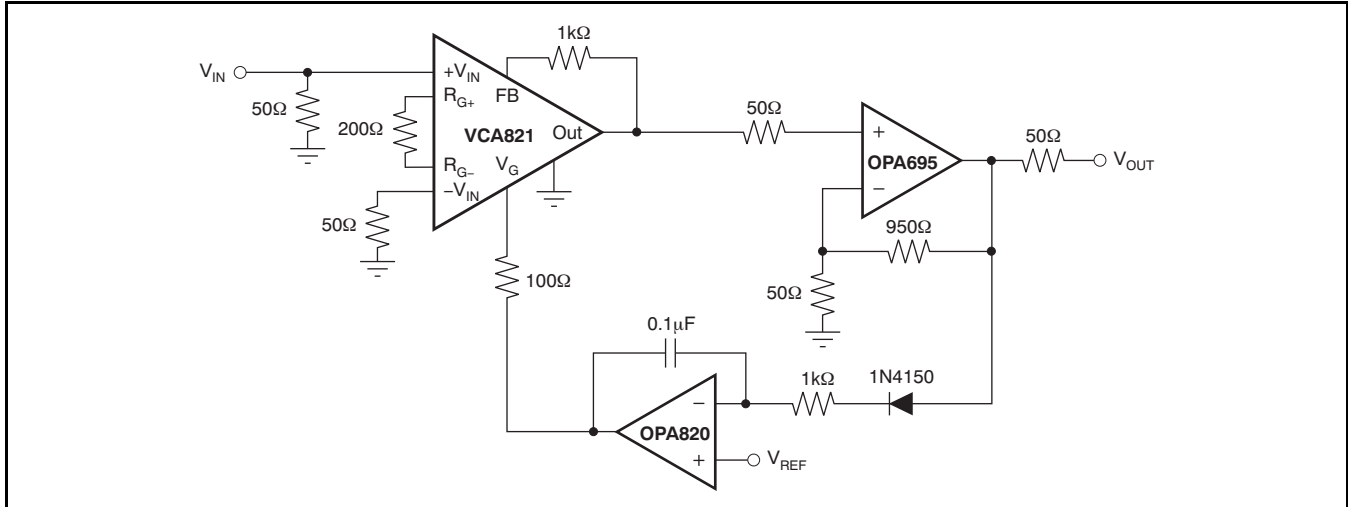

Figure 81. AGC Loop

DESIGN-IN TOOLS

DEMONSTRATION BOARDS

Two printed circuit boards (PCBs) are available to assist in the initial evaluation of circuit performance using the VCA821 in its two package options. Both of these are offered free of charge as unpopulated PCBs, delivered with a user's guide. The summary information for these fixtures is shown in [Table 1](#).

Table 1. EVM Ordering Information

PRODUCT	PACKAGE	BOARD PART NUMBER	LITERATURE REQUEST NUMBER
VCA821ID	SO-14	DEM-VCA-SO-1B	SBOU050
VCA821IDGS	MSOP-10	DEM-VCA-MSOP-1A	SBOU051

The demonstration fixtures can be requested at the Texas Instruments web site (www.ti.com) through the VCA821 product folder.

MACROMODELS AND APPLICATIONS SUPPORT

Computer simulation of circuit performance using SPICE is often useful when analyzing the performance of analog circuits and systems. This principle is particularly true for video and RF amplifier circuits where parasitic capacitance and inductance can play a major role in circuit performance. A [SPICE model](#) for the VCA821 is available through the TI web page. The applications group is also available for design assistance. The models available from TI

predict typical small-signal ac performance, transient steps, dc performance, and noise under a wide variety of operating conditions. The models include the noise terms found in the electrical specifications of the relevant product data sheet.

OPERATING SUGGESTIONS

Operating the VCA821 optimally for a specific application requires trade-offs between bandwidth, input dynamic range and the maximum input voltage, the maximum gain of operation and gain, output dynamic range and the maximum input voltage, the package used, loading, and layout and bypass recommendations. The [Typical Characteristics](#) have been defined to cover as much ground as possible to describe the VCA821 operation. There are four sections in the [Typical Characteristics](#):

- $V_S = \pm 5V$ [DC Parameters](#) and $V_S = \pm 5V$ [DC and Power-Supply Parameters](#), which include dc operation and the intrinsic limitation of a VCA821 design
- $V_S = \pm 5V$, $A_{VMAX} = 6dB$ [Gain of 6dB Operation](#)
- $V_S = \pm 5V$, $A_{VMAX} = 20dB$ [Gain of 20dB Operation](#)
- $V_S = \pm 5V$, $A_{VMAX} = 32dB$ [Gain of 32dB Operation](#)

Where the Typical Characteristics describe the actual performance that can be achieved by using the amplifier properly, the following sections describe in detail the trade-offs needed to achieve this level of performance.

PACKAGE CONSIDERATIONS

The VCA821 is available in both SO-14 and MSOP-10 packages. Each package has, for the different gains used in the typical characteristics, different values of R_F and R_G in order to achieve the same performance detailed in the [Electrical Characteristics](#) table.

Figure 82 shows a test gain circuit for the VCA821. Table 2 lists the recommended configuration for the SO-14 and MSOP-10 packages.

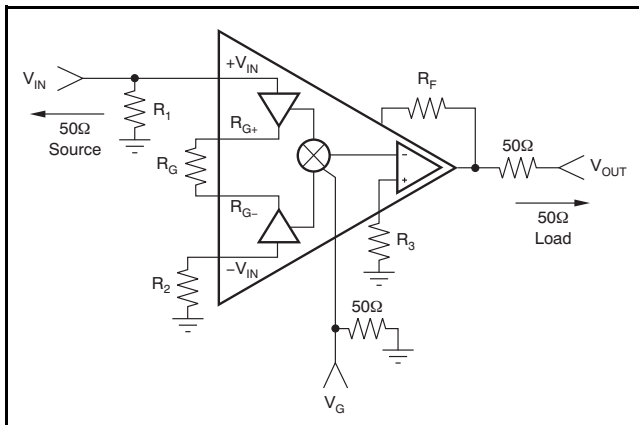

Figure 82. Test Circuit

Table 2. SO-14 and MSOP-10 R_F and R_G Configurations

	$G = 2$	$G = 10$	$G = 40$
R_F	453Ω	402Ω	402Ω
R_G	453Ω	80Ω	18Ω

There are no differences between the packages in the recommended values for the gain and feedback resistors. However, the bandwidth for the VCA821IDGS (MSOP-10 package) is lower than the bandwidth for the VCA821ID (SO-14 package). This difference is true for all gains, but especially true for gains greater than 5V/V, as can be seen in Figure 83 and Figure 84. Note that the scale must be changed to a linear scale to view the details.

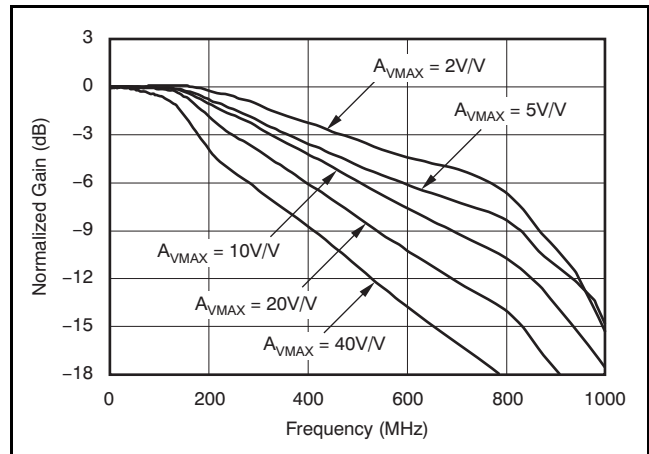

Figure 83. SO-14 Recommended R_F and R_G versus A_{VMAX}

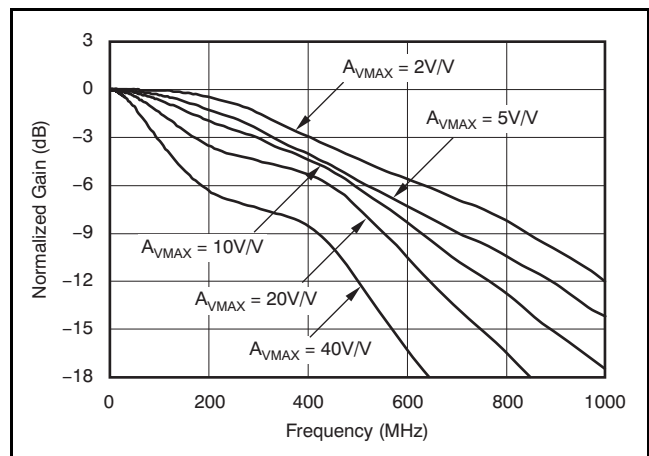

Figure 84. MSOP-10 Recommended R_F and R_G versus A_{VMAX}

MAXIMUM GAIN OF OPERATION

This section describes the use of the VCA821 in a fixed-gain application in which the V_G control pin is set at $V_G = +1V$. The tradeoffs described here are with bandwidth, gain, and output voltage range.

In the case of an application that does not make use of the V_{GAIN} , but requires some other characteristic of the VCA821, the R_G resistor must be set such that the maximum current flowing through the resistance I_{RG} is less than $\pm 2.6mA$ typical, or $5.2mA_{PP}$ as defined in the [Electrical Characteristics](#) table, and must follow [Equation 2](#).

$$I_{RG} = \frac{V_{OUT}}{A_{VMAX} \times R_G} \quad (2)$$

As [Equation 2](#) illustrates, once the output dynamic range and maximum gain are defined, the gain resistor is set. This gain setting in turn affects the bandwidth, because in order to achieve the gain (and with a set gain element), the feedback element of the output stage amplifier is set as well. Keeping in mind that the output amplifier of the VCA821 is a current-feedback amplifier, the larger the feedback element, the lower the bandwidth because the feedback resistor is the compensation element.

Limiting the discussion to the input voltage only and ignoring the output voltage and gain, [Figure 1](#) illustrates the tradeoff between the input voltage and the current flowing through the gain resistor.

OUTPUT CURRENT AND VOLTAGE

The VCA821 provides output voltage and current capabilities that are unsurpassed in a low-cost monolithic VCA. Under no-load conditions at $+25^\circ C$, the output voltage typically swings closer than 1V to either supply rails; the $+25^\circ C$ swing limit is within 1.2V of either rails. Into a 15Ω load (the minimum tested load), it is tested to deliver more than $\pm 90mA$.

The specifications described above, though familiar in the industry, consider voltage and current limits separately. In many applications, it is the voltage \times current, or $V-I$ product, that is more relevant to circuit operation. Refer to the *Output Voltage and Current Limitations* plot ([Figure 48](#)) in the *Typical Characteristics*. The X- and Y-axes of this graph show the zero-voltage output current limit and the zero-current output voltage limit, respectively. The four quadrants give a more detailed view of the VCA821 output drive capabilities, noting that the graph is bounded by a *Safe Operating Area* of 1W maximum internal power dissipation. Superimposing resistor load lines onto the plot shows that the

VCA821 can drive $\pm 2.5V$ into 25Ω or $\pm 3.5V$ into 50Ω without exceeding the output capabilities or the 1W dissipation limit. A 100Ω load line (the standard test circuit load) shows the full $\pm 3.9V$ output swing capability, as shown in the [Typical Characteristics](#).

The minimum specified output voltage and current over-temperature are set by worst-case simulations at the cold temperature extreme. Only at cold startup do the output current and voltage decrease to the numbers shown in the [Electrical Characteristics](#) tables. As the output transistors deliver power, the respective junction temperatures increase, thereby increasing the available output voltage swing and output current.

In steady-state operation, the available output voltage and current are always greater than the temperature shown in the over-temperature specifications because the output stage junction temperatures are higher than the specified operating ambient.

INPUT VOLTAGE DYNAMIC RANGE

The VCA821 has an input dynamic range limited to $+1.6V$ and $-2.1V$. Increasing the input voltage dynamic range can be done by using an attenuator network on the input. If the VCA821 is trying to regulate the amplitude at the output, such as in an AGC application, the input voltage dynamic range is directly proportional to [Equation 3](#).

$$V_{IN(PP)} = R_G \times I_{RG(PP)} \quad (3)$$

As such, for unity-gain or under-attenuated conditions, the input voltage must be limited to the CMIR of $\pm 1.6V$ ($3.2V_{PP}$) and the current (I_{RG}) must flow through the gain resistor, $\pm 2.6mA$ ($5.2mA_{PP}$). This configuration sets a minimum value for R_E such that the gain resistor must be greater than [Equation 4](#).

$$R_{GMIN} = \frac{3.2V_{PP}}{5.2mA_{PP}} = 615.4\Omega \quad (4)$$

Values lower than 615.4Ω are gain elements that result in reduced input range, as the dynamic input range is limited by the current flowing through the gain resistor R_G (I_{RG}). If the I_{RG} current limits the performance of the circuit, the input stage of the VCA821 goes into overdrive, resulting in limited output voltage range. Such I_{RG} -limited overdrive conditions are shown in [Figure 50](#) for the gain of 20dB and [Figure 70](#) for the 32dB gain.

OUTPUT VOLTAGE DYNAMIC RANGE

With its large output current capability and its wide output voltage swing of $\pm 3.9V$ typical on 100Ω load, it is easy to forget other types of limitations that the VCA821 can encounter. For these limitations, careful analysis must be done to avoid input stage limitation: either voltage or I_{RG} current. Note that if control pin V_G varies, the gain limitation may affect other aspects of the circuit.

BANDWIDTH

The output stage of the VCA821 is a wideband current-feedback amplifier. As such, the feedback resistance is the compensation of the last stage. Reducing the feedback element and maintaining the gain constant limits the useful range of I_{RG} , and therefore, reduces the gain adjust range. For a given gain, reducing the gain element limits the maximum achievable output voltage swing.

OFFSET ADJUSTMENT

As a result of the internal architecture used on the VCA821, the output offset voltage originates from the output stage and from the input stage and multiplier core. Figure 85 shows how to compensate both sources of the output offset voltage. Use this procedure to compensate the output offset voltage: starting with the output stage compensation, set $V_G = -1V$ to eliminate all offset contribution of the input stage and multiplier core. Adjust the output stage offset compensation potentiometer. Finally, set $V_G = +1V$ to the maximum gain and adjust the input stage and multiplier core potentiometer. This procedure effectively eliminates all offset contribution at the maximum gain. Because adjusting the gain modifies the contribution of the input stage and the multiplier core, some residual output offset voltage remains.

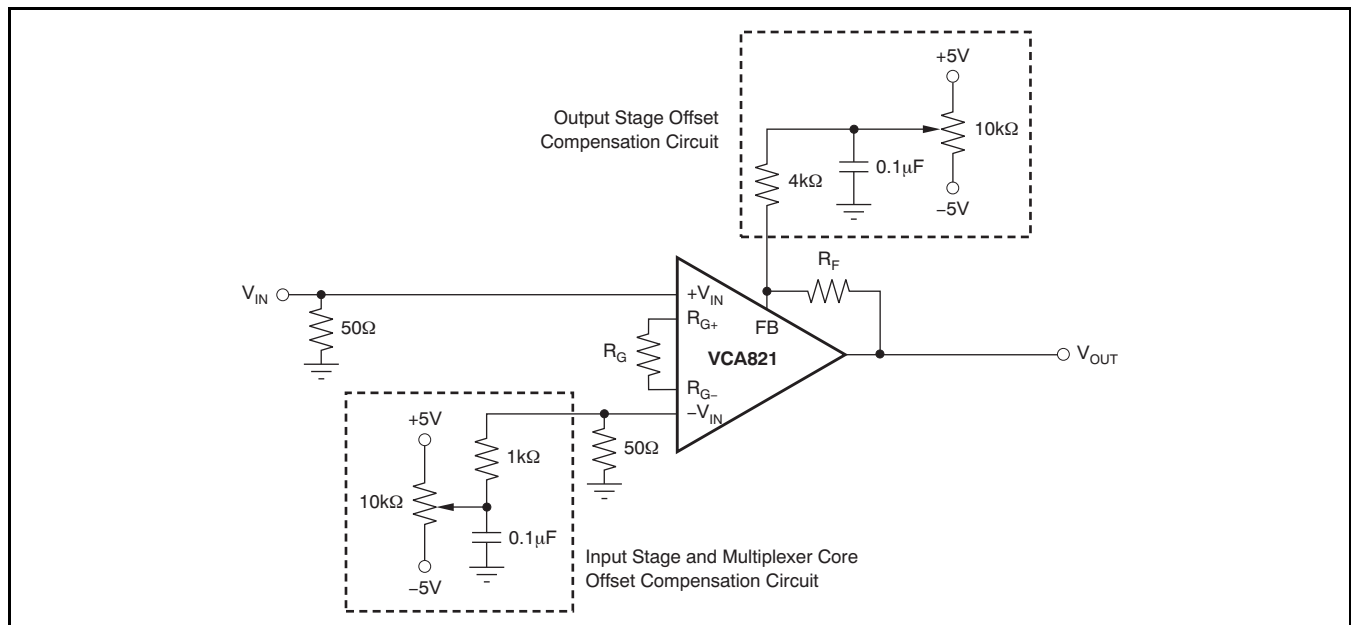

Figure 85. Adjusting the Input and Output Voltage Sources

NOISE

The VCA821 offers $6\text{nV}/\sqrt{\text{Hz}}$ input-referred voltage noise density at a gain of 20dB and $2.6\text{pA}/\sqrt{\text{Hz}}$ input-referred current noise density. The input-referred voltage noise density considers that all noise terms (except the input current noise but including the thermal noise of both the feedback resistor and the gain resistor) are expressed as one term.

This model is formulated in Equation 5 and Figure 86.

$$e_o = A_{V_{MAX}} \times \sqrt{2 \times (R_s \times i_n)^2 + e_n^2 + 2 \times 4kTR_s} \quad (5)$$

A more complete model is shown in Figure 87. For additional information on this model and the actual modeled noise terms, please contact the High-Speed Product Application Support team at www.ti.com.

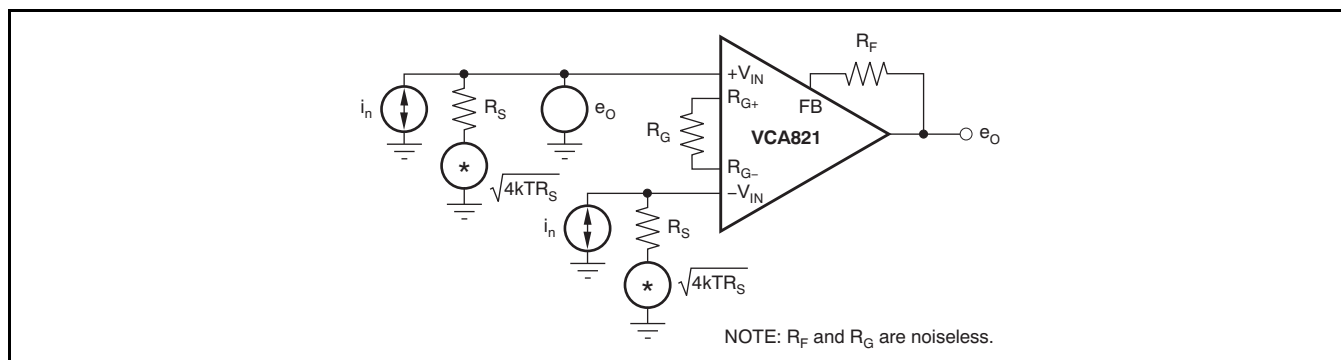

Figure 86. Simple Noise Model

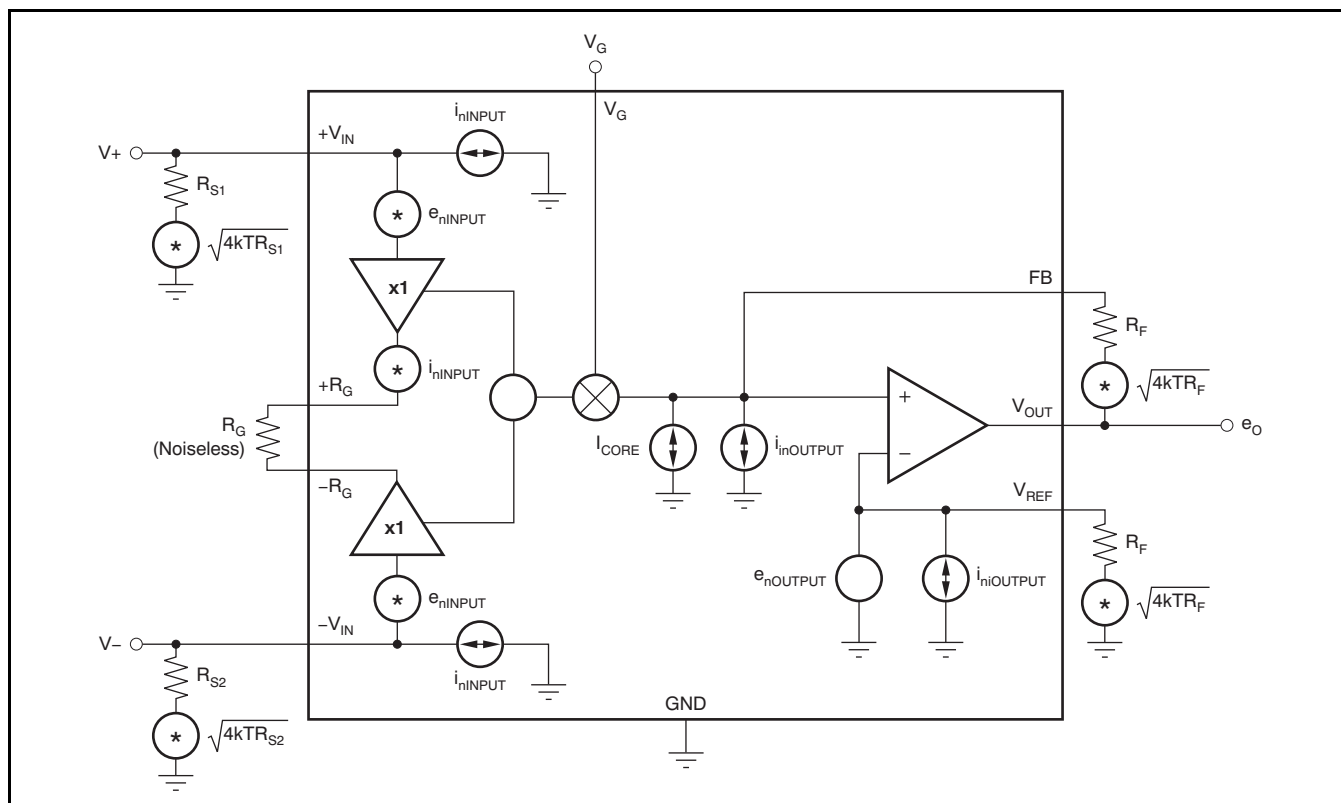

Figure 87. Full Noise Model

THERMAL ANALYSIS

The VCA821 does not require heatsinking or airflow in most applications. The maximum desired junction temperature sets the maximum allowed internal power dissipation as described in this section. In no case should the maximum junction temperature be allowed to exceed +150°C.

Operating junction temperature (T_J) is given by [Equation 6](#):

$$T_J = T_A + P_D \times \theta_{JA} \quad (6)$$

The total internal power dissipation (P_D) is the sum of quiescent power (P_{DQ}) and additional power dissipated in the output stage (P_{DL}) to deliver load power. Quiescent power is simply the specified no-load supply current times the total supply voltage across the part. P_{DL} depends on the required output signal and load; for a grounded resistive load, however, it is at a maximum when the output is fixed at a voltage equal to one-half of either supply voltage (for equal bipolar supplies). Under this worst-case condition, $P_{DL} = V_S^2 / (4 \times R_L)$, where R_L is the resistive load.

Note that it is the power in the output stage and not in the load that determines internal power dissipation. As a worst-case example, compute the maximum T_J using a VCA821ID (SO-14 package) in the circuit of [Figure 74](#) operating at maximum gain and at the maximum specified ambient temperature of +85°C.

$$P_D = 10V(36mA) + 5^2 / (4 \times 100\Omega) = 422.5mW \quad (7)$$

$$\text{Maximum } T_J = +85^\circ\text{C} + (0.443W \times 80^\circ\text{C/W}) = 120.5^\circ\text{C} \quad (8)$$

This maximum operating junction temperature is well below most system level targets. Most applications should be lower because an absolute worst-case output stage power was assumed in this calculation of $V_{CC}/2$, which is beyond the output voltage range for the VCA821.

BOARD LAYOUT

Achieving optimum performance with a high-frequency amplifier such as the VCA821 requires careful attention to printed circuit board (PCB) layout parasitics and external component types. Recommendations to optimize performance include:

a) Minimize parasitic capacitance to any ac ground for all of the signal I/O pins. This recommendation includes the ground pin (pin 2). Parasitic capacitance on the output can cause instability: on both the inverting input and the noninverting input, it can react with the source impedance to cause unintentional

band limiting. To reduce unwanted capacitance, a window around the signal I/O pins should be opened in all of the ground and power planes around those pins. Otherwise, ground and power planes should be unbroken elsewhere on the board. Place a small series resistance (greater than 25 Ω) with the input pin connected to ground to help decouple package parasitics.

b) Minimize the distance (less than 0.25 inches, or 6.3mm) from the power-supply pins to high-frequency 0.1 μ F decoupling capacitors. At the device pins, the ground and power plane layout should not be in close proximity to the signal I/O pins. Avoid narrow power and ground traces to minimize inductance between the pins and the decoupling capacitors. The power-supply connections should always be decoupled with these capacitors. Larger (2.2 μ F to 6.8 μ F) decoupling capacitors, effective at lower frequencies, should also be used on the main supply pins. These capacitors may be placed somewhat farther from the device and may be shared among several devices in the same area of the PCB.

c) Careful selection and placement of external components preserve the high-frequency performance of the VCA821. Resistors should be a very low reactance type. Surface-mount resistors work best and allow a tighter overall layout. Metal-film and carbon composition, axially-leaded resistors can also provide good high-frequency performance. Again, keep the leads and PCB trace length as short as possible. Never use wire-wound type resistors in a high-frequency application. Because the output pin is the most sensitive to parasitic capacitance, always position the series output resistor, if any, as close as possible to the output pin. Other network components, such as inverting or non-inverting input termination resistors, should also be placed close to the package.

d) Connections to other wideband devices on the board may be made with short direct traces or through onboard transmission lines. For short connections, consider the trace and the input to the next device as a lumped capacitive load. Relatively wide traces (50mils to 100mils, or 1.27mm to 2.54mm) should be used, preferably with ground and power planes opened up around them.

e) Socketing a high-speed part like the VCA821 is not recommended. The additional lead length and pin-to-pin capacitance introduced by the socket can create an extremely troublesome parasitic network, which can make it almost impossible to achieve a smooth, stable frequency response. Best results are obtained by soldering the VCA821 onto the board.

INPUT AND ESD PROTECTION

The VCA821 is built using a very high-speed complementary bipolar process. The internal junction breakdown voltages are relatively low for these very small geometry devices. These breakdowns are reflected in the [Section 2](#) table.

All pins on the VCA821 are internally protected from ESD by means of a pair of back-to-back reverse-biased diodes to either power supply, as shown in [Figure 88](#). These diodes begin to conduct when the pin voltage exceeds either power supply by about 0.7V. This situation can occur with loss of the amplifier power supplies while a signal source is still present. The diodes can typically withstand a continuous current of 30mA without destruction. To ensure long-term reliability, however, diode current should be externally limited to 10mA whenever possible.

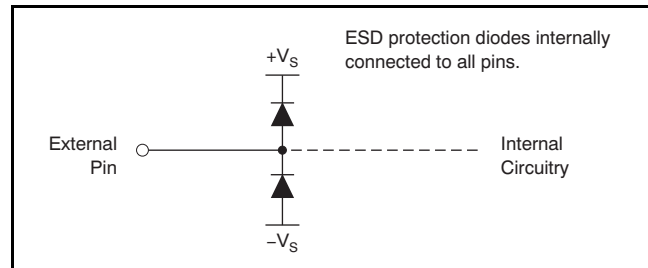

Figure 88. Internal ESD Protection

Revision History

Changes from Original (December 2007) to Revision A	Page
<ul style="list-style-type: none">Changed storage temperature range rating in <i>Absolute Maximum Ratings</i> table from -40°C to $+125^{\circ}\text{C}$ to -65°C to $+125^{\circ}\text{C}$	2

PACKAGING INFORMATION

Orderable Device	Status ⁽¹⁾	Package Type	Package Drawing	Pins	Package Qty	Eco Plan ⁽²⁾	Lead/Ball Finish	MSL Peak Temp ⁽³⁾
VCA821ID	ACTIVE	SOIC	D	14	50	Green (RoHS & no Sb/Br)	CU NIPDAU	Level-2-260C-1 YEAR
VCA821IDG4	ACTIVE	SOIC	D	14	50	Green (RoHS & no Sb/Br)	CU NIPDAU	Level-2-260C-1 YEAR
VCA821IDGSR	ACTIVE	MSOP	DGS	10	2500	Green (RoHS & no Sb/Br)	CU NIPDAU	Level-2-260C-1 YEAR
VCA821IDGSRG4	ACTIVE	MSOP	DGS	10	2500	Green (RoHS & no Sb/Br)	CU NIPDAU	Level-2-260C-1 YEAR
VCA821IDGST	ACTIVE	MSOP	DGS	10	250	Green (RoHS & no Sb/Br)	CU NIPDAU	Level-2-260C-1 YEAR
VCA821IDGSTG4	ACTIVE	MSOP	DGS	10	250	Green (RoHS & no Sb/Br)	CU NIPDAU	Level-2-260C-1 YEAR
VCA821IDR	ACTIVE	SOIC	D	14	2500	Green (RoHS & no Sb/Br)	CU NIPDAU	Level-2-260C-1 YEAR
VCA821IDRG4	ACTIVE	SOIC	D	14	2500	Green (RoHS & no Sb/Br)	CU NIPDAU	Level-2-260C-1 YEAR

⁽¹⁾ The marketing status values are defined as follows:

ACTIVE: Product device recommended for new designs.

LIFEBUY: TI has announced that the device will be discontinued, and a lifetime-buy period is in effect.

NRND: Not recommended for new designs. Device is in production to support existing customers, but TI does not recommend using this part in a new design.

PREVIEW: Device has been announced but is not in production. Samples may or may not be available.

OBSOLETE: TI has discontinued the production of the device.

⁽²⁾ Eco Plan - The planned eco-friendly classification: Pb-Free (RoHS), Pb-Free (RoHS Exempt), or Green (RoHS & no Sb/Br) - please check <http://www.ti.com/productcontent> for the latest availability information and additional product content details.

TBD: The Pb-Free/Green conversion plan has not been defined.

Pb-Free (RoHS): TI's terms "Lead-Free" or "Pb-Free" mean semiconductor products that are compatible with the current RoHS requirements for all 6 substances, including the requirement that lead not exceed 0.1% by weight in homogeneous materials. Where designed to be soldered at high temperatures, TI Pb-Free products are suitable for use in specified lead-free processes.

Pb-Free (RoHS Exempt): This component has a RoHS exemption for either 1) lead-based flip-chip solder bumps used between the die and package, or 2) lead-based die adhesive used between the die and leadframe. The component is otherwise considered Pb-Free (RoHS compatible) as defined above.

Green (RoHS & no Sb/Br): TI defines "Green" to mean Pb-Free (RoHS compatible), and free of Bromine (Br) and Antimony (Sb) based flame retardants (Br or Sb do not exceed 0.1% by weight in homogeneous material)

⁽³⁾ MSL, Peak Temp. -- The Moisture Sensitivity Level rating according to the JEDEC industry standard classifications, and peak solder temperature.

Important Information and Disclaimer:The information provided on this page represents TI's knowledge and belief as of the date that it is provided. TI bases its knowledge and belief on information provided by third parties, and makes no representation or warranty as to the accuracy of such information. Efforts are underway to better integrate information from third parties. TI has taken and continues to take reasonable steps to provide representative and accurate information but may not have conducted destructive testing or chemical analysis on incoming materials and chemicals. TI and TI suppliers consider certain information to be proprietary, and thus CAS numbers and other limited information may not be available for release.

In no event shall TI's liability arising out of such information exceed the total purchase price of the TI part(s) at issue in this document sold by TI to Customer on an annual basis.

TAPE AND REEL INFORMATION

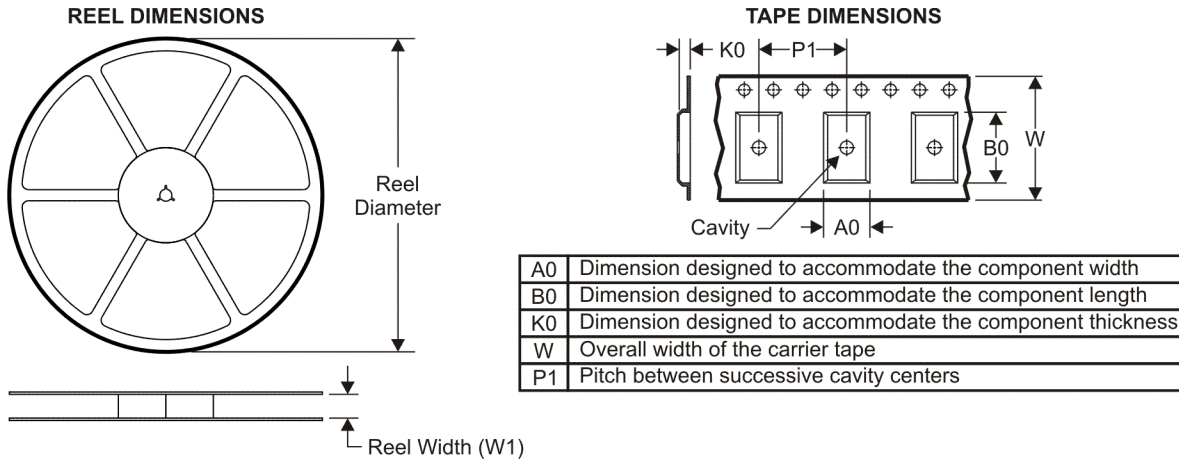

QUADRANT ASSIGNMENTS FOR PIN 1 ORIENTATION IN TAPE

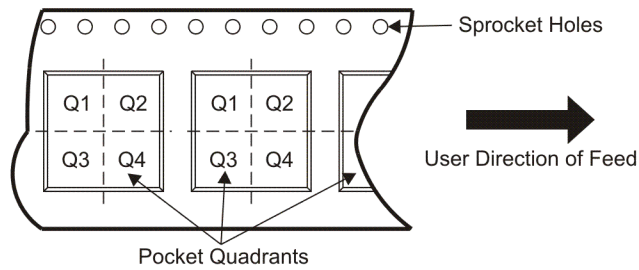

*All dimensions are nominal

Device	Package Type	Package Drawing	Pins	SPQ	Reel Diameter (mm)	Reel Width W1 (mm)	A0 (mm)	B0 (mm)	K0 (mm)	P1 (mm)	W (mm)	Pin1 Quadrant
VCA821IDGSR	MSOP	DGS	10	2500	330.0	12.4	5.3	3.4	1.4	8.0	12.0	Q1
VCA821IDGST	MSOP	DGS	10	250	180.0	12.4	5.3	3.4	1.4	8.0	12.0	Q1
VCA821IDR	SOIC	D	14	2500	330.0	16.4	6.5	9.0	2.1	8.0	16.0	Q1

TAPE AND REEL BOX DIMENSIONS

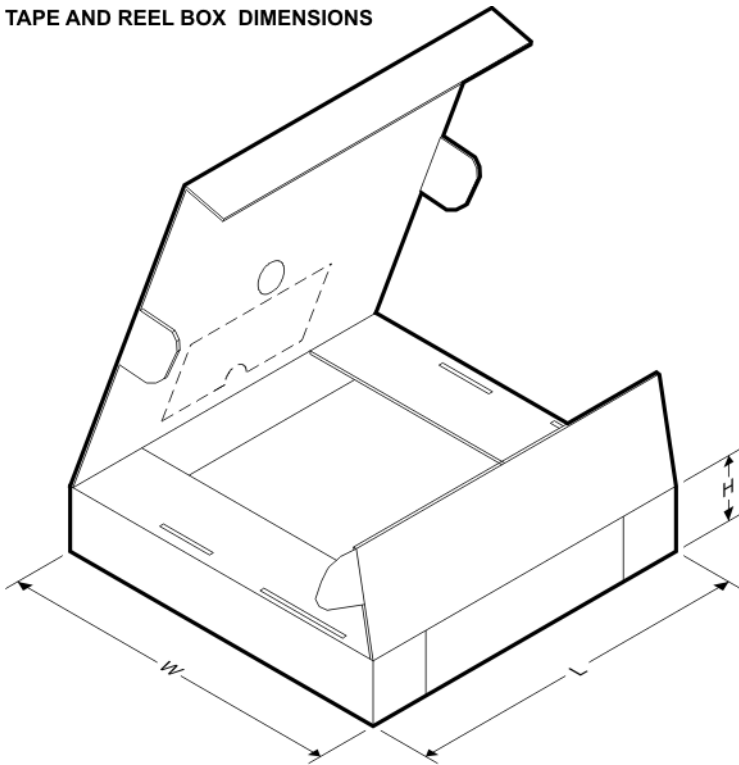

*All dimensions are nominal

Device	Package Type	Package Drawing	Pins	SPQ	Length (mm)	Width (mm)	Height (mm)
VCA821IDGSR	MSOP	DGS	10	2500	346.0	346.0	29.0
VCA821IDGST	MSOP	DGS	10	250	190.5	212.7	31.8
VCA821IDR	SOIC	D	14	2500	346.0	346.0	33.0

DGS (S-PDSO-G10)

PLASTIC SMALL-OUTLINE PACKAGE

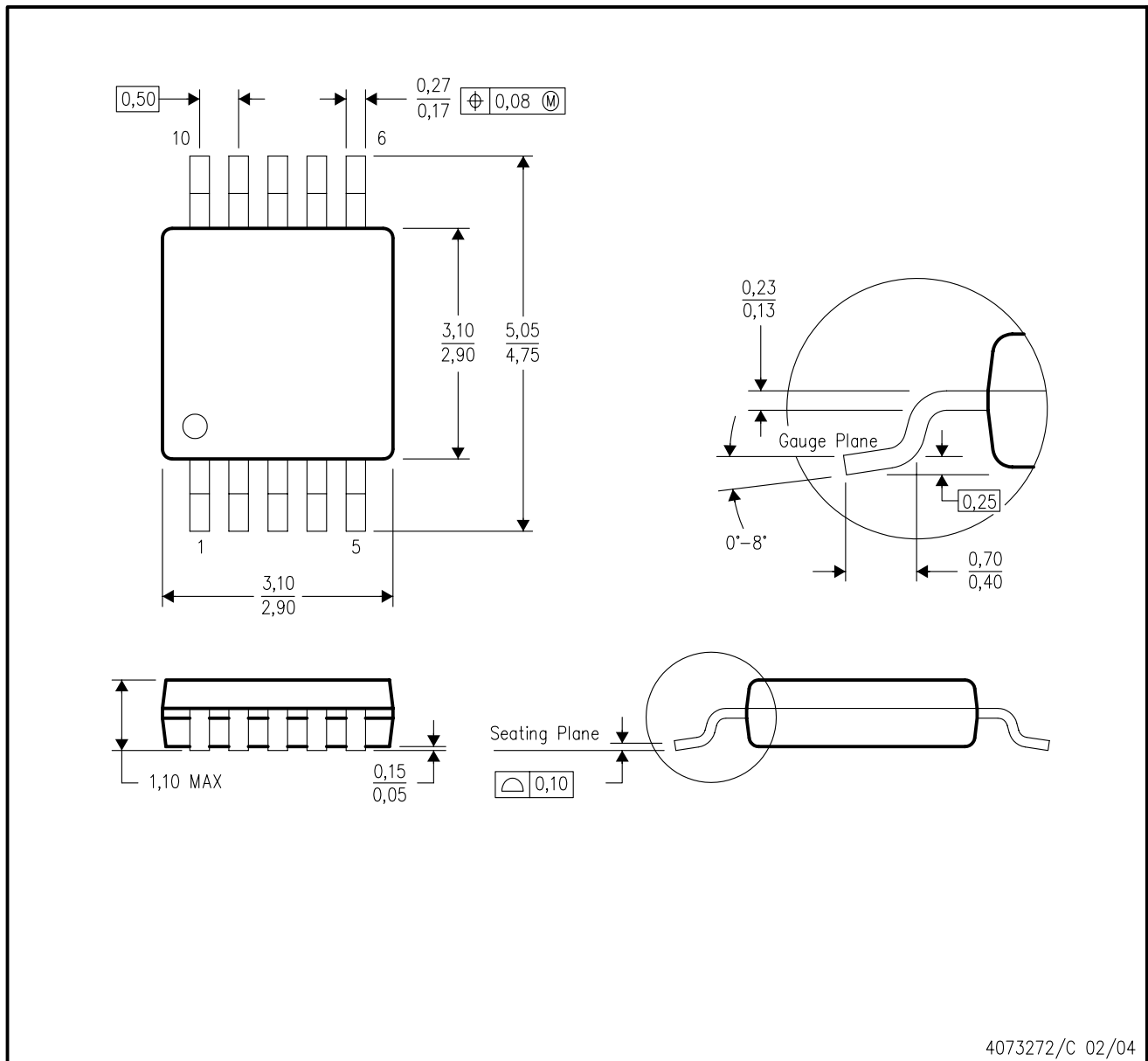

- NOTES:
- A. All linear dimensions are in millimeters.
 - B. This drawing is subject to change without notice.
 - C. Body dimensions do not include mold flash or protrusion.
 - D. Falls within JEDEC MO-187 variation BA.

D (R-PDSO-G14)

PLASTIC SMALL-OUTLINE PACKAGE

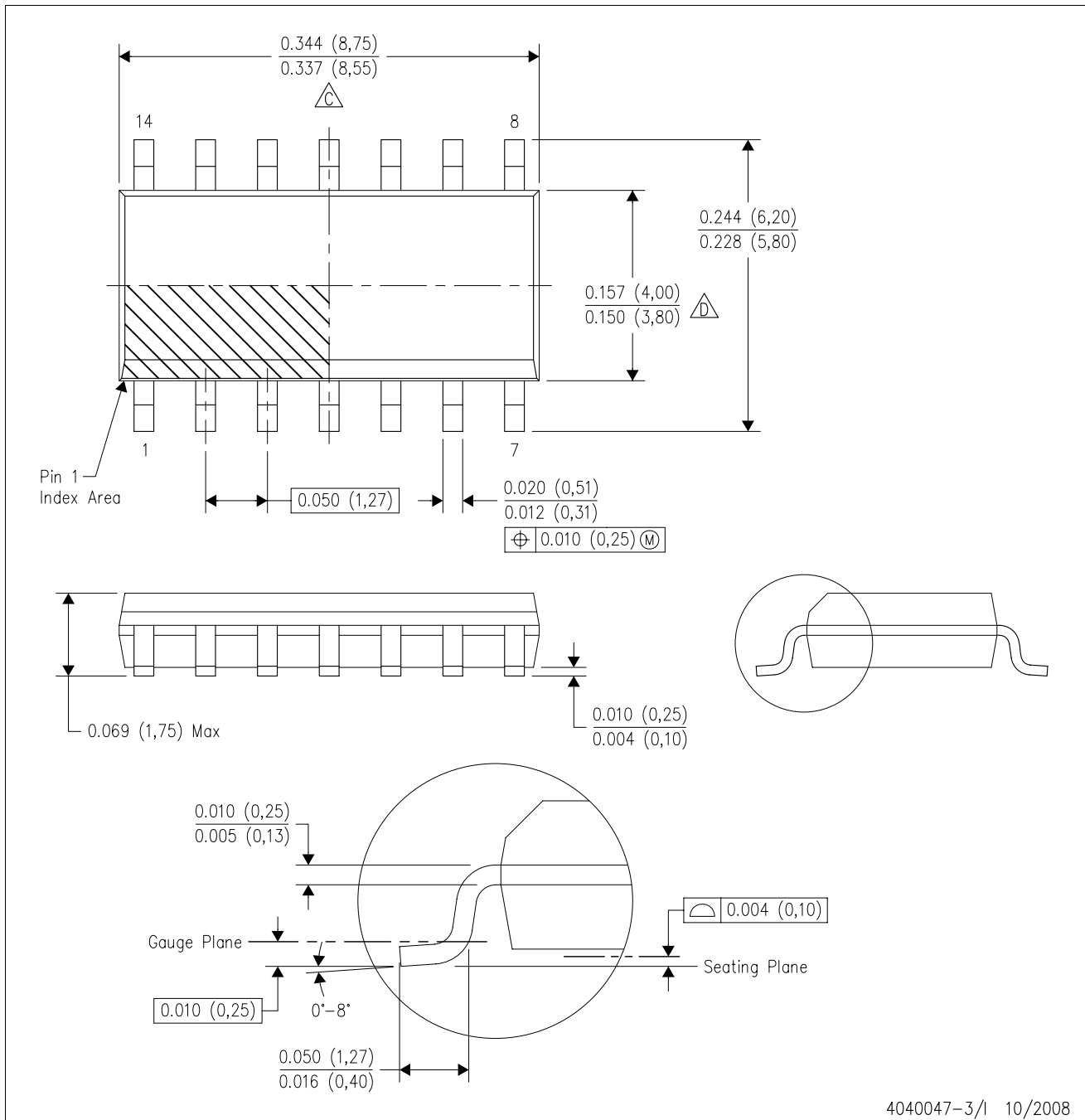

- NOTES:
- A. All linear dimensions are in inches (millimeters).
 - B. This drawing is subject to change without notice.
 - C. Body length does not include mold flash, protrusions, or gate burrs. Mold flash, protrusions, or gate burrs shall not exceed .006 (0,15) per end.
 - D. Body width does not include interlead flash. Interlead flash shall not exceed .017 (0,43) per side.
 - E. Reference JEDEC MS-012 variation AB.

IMPORTANT NOTICE

Texas Instruments Incorporated and its subsidiaries (TI) reserve the right to make corrections, modifications, enhancements, improvements, and other changes to its products and services at any time and to discontinue any product or service without notice. Customers should obtain the latest relevant information before placing orders and should verify that such information is current and complete. All products are sold subject to TI's terms and conditions of sale supplied at the time of order acknowledgment.

TI warrants performance of its hardware products to the specifications applicable at the time of sale in accordance with TI's standard warranty. Testing and other quality control techniques are used to the extent TI deems necessary to support this warranty. Except where mandated by government requirements, testing of all parameters of each product is not necessarily performed.

TI assumes no liability for applications assistance or customer product design. Customers are responsible for their products and applications using TI components. To minimize the risks associated with customer products and applications, customers should provide adequate design and operating safeguards.

TI does not warrant or represent that any license, either express or implied, is granted under any TI patent right, copyright, mask work right, or other TI intellectual property right relating to any combination, machine, or process in which TI products or services are used. Information published by TI regarding third-party products or services does not constitute a license from TI to use such products or services or a warranty or endorsement thereof. Use of such information may require a license from a third party under the patents or other intellectual property of the third party, or a license from TI under the patents or other intellectual property of TI.

Reproduction of TI information in TI data books or data sheets is permissible only if reproduction is without alteration and is accompanied by all associated warranties, conditions, limitations, and notices. Reproduction of this information with alteration is an unfair and deceptive business practice. TI is not responsible or liable for such altered documentation. Information of third parties may be subject to additional restrictions.

Resale of TI products or services with statements different from or beyond the parameters stated by TI for that product or service voids all express and any implied warranties for the associated TI product or service and is an unfair and deceptive business practice. TI is not responsible or liable for any such statements.

TI products are not authorized for use in safety-critical applications (such as life support) where a failure of the TI product would reasonably be expected to cause severe personal injury or death, unless officers of the parties have executed an agreement specifically governing such use. Buyers represent that they have all necessary expertise in the safety and regulatory ramifications of their applications, and acknowledge and agree that they are solely responsible for all legal, regulatory and safety-related requirements concerning their products and any use of TI products in such safety-critical applications, notwithstanding any applications-related information or support that may be provided by TI. Further, Buyers must fully indemnify TI and its representatives against any damages arising out of the use of TI products in such safety-critical applications.

TI products are neither designed nor intended for use in military/aerospace applications or environments unless the TI products are specifically designated by TI as military-grade or "enhanced plastic." Only products designated by TI as military-grade meet military specifications. Buyers acknowledge and agree that any such use of TI products which TI has not designated as military-grade is solely at the Buyer's risk, and that they are solely responsible for compliance with all legal and regulatory requirements in connection with such use.

TI products are neither designed nor intended for use in automotive applications or environments unless the specific TI products are designated by TI as compliant with ISO/TS 16949 requirements. Buyers acknowledge and agree that, if they use any non-designated products in automotive applications, TI will not be responsible for any failure to meet such requirements.

Following are URLs where you can obtain information on other Texas Instruments products and application solutions:

Products

Amplifiers	amplifier.ti.com
Data Converters	dataconverter.ti.com
DSP	dsp.ti.com
Clocks and Timers	www.ti.com/clocks
Interface	interface.ti.com
Logic	logic.ti.com
Power Mgmt	power.ti.com
Microcontrollers	microcontroller.ti.com
RFID	www.ti-rfid.com
RF/IF and ZigBee® Solutions	www.ti.com/lprf

Applications

Audio	www.ti.com/audio
Automotive	www.ti.com/automotive
Broadband	www.ti.com/broadband
Digital Control	www.ti.com/digitalcontrol
Medical	www.ti.com/medical
Military	www.ti.com/military
Optical Networking	www.ti.com/opticalnetwork
Security	www.ti.com/security
Telephony	www.ti.com/telephony
Video & Imaging	www.ti.com/video
Wireless	www.ti.com/wireless

Mailing Address: Texas Instruments, Post Office Box 655303, Dallas, Texas 75265
Copyright © 2008, Texas Instruments Incorporated